

DRAFT



DATA BOOK

INVERTER MULTI-SPLIT SYSTEM RESIDENTIAL AIR-CONDITIONERS (Split system, air to air heat pump type)

(OUTDOOR UNIT)

**SCM50ZS-W
60ZS-W**

(INDOOR UNIT)

Wall mounted type

**SRK20ZSX-W,-WB,-WT
25ZSX-W,-WB,-WT
35ZSX-W,-WB,-WT
50ZSX-W,-WB,-WT
60ZSX-W,-WB,-WT**

**SRK20ZS-W,-WB,-WT
25ZS-W,-WB,-WT
35ZS-W,-WB,-WT
50ZS-W,-WB,-WT**

**SKM20ZSP-W
25ZSP-W
35ZSP-W**

Ceiling concealed type

**SRR25ZM-W
35ZM-W
50ZS-W
60ZS-W**

4-way ceiling cassette type

**FDTC25VH
35VH
50VH
60VH**

**Duct connected Low/Middle static pressure type
FDUM50VH**

**Ceiling suspended type
FDE50VH**

■ Table of models

Indoor unit		Outdoor unit to be combined	
Type	Model	SCM50ZS-W	SCM60ZS-W
Wall mounted type	SRK20ZSX-W,-WB,-WT	○	○
	25ZSX-W,-WB,-WT	○	○
	35ZSX-W,-WB,-WT	○	○
	50ZSX-W,-WB,-WT	○	○
	60ZSX-W,-WB,-WT	—	○
	SRK20ZS-W,-WB,-WT	○	○
	25ZS-W,-WB,-WT	○	○
	35ZS-W,-WB,-WT	○	○
	50ZS-W,-WB,-WT	○	○
	SKM20ZSP-W	○	○
	25ZSP-W	○	○
	35ZSP-W	○	○
Ceiling concealed type	SRR25ZM-W	○	○
	35ZM-W	○	○
	50ZS-W	○	○
	60ZS-W	—	○
4-way ceiling cassette type	FDTC25VH	○	○
	35VH	○	○
	50VH	○	○
	60VH	—	○
Duct connected Low/Middle static pressure type	FDUM50VH	○	○
Ceiling suspended type	FDE50VH	○	○

■ How to read the model name

Outdoor unit

Example: **SCM 50 Z S-W**

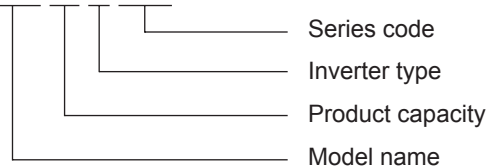

Indoor unit

Example: **SRK 20 Z SX-W**

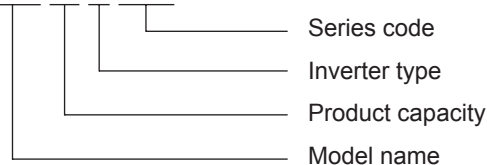

SRK,SKM : Wall mounted type
SRR : Ceiling concealed type
FDTC : 4-way ceiling cassette type
FDE : Ceiling suspended type
FDUM : Duct connected Low/Middle static pressure type

1. OUTDOOR UNITS

1.1 Specifications

Item		Model	SCM50ZS-W			
Power source			1 Phase, 220 - 240V, 50Hz / 220V, 60Hz			
Operation data (1)	Nominal cooling capacity (Range)	kW	5.0 (1.7 (Min.) - 7.1 (Max.))			
	Nominal heating capacity (Range)	kW	6.0 (1.0(Min.) - 7.5 (Max.))			
	Heating capacity (H2)	kW	-			
	Power consumption	Cooling	kW	1.02 (0.43 - 2.15)		
		Heating		1.16 (0.32 - 2.50)		
		Heating (H2)		-		
	Max power consumption		2.8			
	Running current	Cooling	A	4.7 / 4.5 / 4.3 (220/ 230/ 240 V)		
		Heating		5.4 / 5.1 / 4.9 (220/ 230/ 240 V)		
	Inrush current, max current		5.0 Max. 15			
	Power factor	Cooling	%	98		
		Heating		98		
	EER	Cooling		4.90		
		Heating		5.17		
	COP	Heating (H2)		-		
Sound power level	Cooling	dB(A)	62			
	Heating		64			
Sound pressure level	Cooling		49			
	Heating		52			
Silent mode sound pressure level			Cooling:43 / Heating:44			
Exterior dimensions (Height x Width x Depth)	mm		640 x 850(+65) x 290			
Exterior appearance (Equivalent color)			Stucco white Munsell : (4.2Y 7.5/1.1), near equivalent			
Net weight	kg		48.5			
Compressor type & Quantity			RMT5113SBE1 (Twin rotary type) x 1			
Compressor motor (Starting method)	kW		1.4 (Line starting)			
Refrigerant oil (Amount, type)	ℓ		0.45 (DIAMOND FREEZE MB75)			
Refrigerant (Type, amount, pre-charge length)	kg		R32 1.8 (Pre-charged up to the piping length of 40m)			
Heat exchanger			M fins & inner grooved tubing			
Refrigerant control			Capillary tubes + Electronic expansion valve			
Device control			Microcomputer control			
Fan type & Quantity			Propeller fan x 1			
Fan motor (Starting method)	W		34			
Air flow	Cooling	m³/min	41			
	Heating		41			
Shock & vibration absorber			Cushion rubber (for compressor)			
Electric heater			-			
Safety equipments			Compressor overheat protection, Overcurrent protection, Frost protection, Serial signal error protection, Outdoor fan motor error protection, Heating&Cooling overload protection			
Installation data	Refrigerant piping size (O.D)	mm	Liquid line: φ 6.35 (1/4") x 3 Gas line: φ 9.52 (3/8") x 3			
	Connecting method		Flare connection			
	Insulation for piping		Necessary (Both sides), independent			
	Refrigerant line (One way) length	m	Max. 25 (Length for one indoor unit) Max. 40 (Total length for all rooms)			
	Vertical height diff. between O.U. and I.U.	m	Max. 15 (Outdoor unit is higher) Max. 15 (Outdoor unit is lower)			
Height difference of the indoor units	m	Max. 25				
Recommended breaker size	A		25			
L.R.A. (Locked rotor ampere)	A		5			
Interconnecting wires	Size x Core number		1.5mm² x 4 cores (Including earth cable)			
	Connecting method		Terminal block (Screw fixing type)			
IP number			IPX4			
Standard accessories			Union : (φ 9.52 → φ 12.7) × 1, Installation sheet, Elbow, Grommet			
Indoor unit to be combined			SRK20,25,35,50ZSX-W(-WB,-WT) SRK20,25,35,50ZS-W(-WB,-WT) SKM20,25,35ZSP-W, SRR25,35ZM-W, SRR50ZS-W FDTC25,35,50VH, FDE50VH, FDUM50VH			
Number of connectable indoor units			Min. 2 - Max. 3			
Total of indoor units	kW		Max. 8.5			
Notes (1) The data are measured at the following conditions.		The pipe length is 5m.				
Operation	Item	Indoor air temperature		Outdoor air temperature		Standards
		DB	WB	DB	WB	
	Cooling	27°C	19°C	35°C	24°C	ISO5151-T1
	Heating	20°C	-	7°C	6°C	ISO5151-H1
Heating (H2)	20°C	-	2°C	1°C	ISO5151-H2	
(2) This air-conditioner is manufactured and tested in conformity with the ISO.						
(3) Sound level indicates the value in an anechoic chamber. During operation these values are somewhat higher due to ambient conditions.						
(4) Select the breaker size according to the own national standard.						

RWC000Z338

Item		Model	SCM60ZS-W	
Power source			1 Phase, 220 - 240V, 50Hz / 220V, 60Hz	
Operation data (1)	Nominal cooling capacity (Range)	kW	6.0 (1.7 (Min.) - 7.5 (Max.))	
	Nominal heating capacity (Range)	kW	6.8 (1.0 (Min.) - 7.8 (Max.))	
	Heating capacity (H2)	kW	-	
	Power consumption	Cooling	kW	1.32 (0.43 - 2.28)
		Heating		1.40 (0.32 - 2.80)
		Heating (H2)		-
	Max power consumption		2.8	
	Running current	Cooling	A	6.1 / 5.8 / 5.6 (220/ 230/ 240 V)
		Heating		6.4 / 6.1 / 5.9 (220/ 230/ 240 V)
	Inrush current, max current		5.0 Max. 15	
	Power factor	Cooling	%	99
		Heating		99
	EER	Cooling		4.55
		Heating		4.86
	COP	Heating (H2)		-
Sound power level	Cooling	dB(A)	62	
	Heating		64	
Sound pressure level	Cooling		50	
	Heating		52	
Silent mode sound pressure level			Cooling:43 / Heating:44	
Exterior dimensions (Height x Width x Depth)	mm		640 x 850(+65) x 290	
Exterior appearance (Equivalent color)			Stucco white Munsell : (4.2Y 7.5/1.1), near equivalent	
Net weight	kg		48.5	
Compressor type & Quantity			RMT5113SBE1 (Twin rotary type) x 1	
Compressor motor (Starting method)	kW		1.4 (Line starting)	
Refrigerant oil (Amount, type)	ℓ		0.45 (DIAMOND FREEZE MB75)	
Refrigerant (Type, amount, pre-charge length)	kg		R32A 1.8 (Pre-charged up to the piping length of 40m)	
Heat exchanger			M fins & inner grooved tubing	
Refrigerant control			Capillary tubes + Electronic expansion valve	
Device control			Microcomputer control	
Fan type & Quantity			Propeller fan x 1	
Fan motor (Starting method)	W		34	
Air flow	Cooling	m ³ /min	41	
	Heating		41	
Shock & vibration absorber			Cushion rubber (for compressor)	
Electric heater			-	
Safety equipments			Compressor overheat protection, Overcurrent protection, Frost protection, Serial signal error protection, Outdoor fan motor error protection, Heating&Cooling overload protection	
Installation data	Refrigerant piping size (O.D)	mm	Liquid line: φ 6.35 (1/4") x 3 Gas line: φ 9.52 (3/8") x 3	
	Connecting method		Flare connection	
	Insulation for piping		Necessary (Both sides), independent	
	Refrigerant line (One way) length	m	Max. 25 (Length for one indoor unit) Max. 40 (Total length for all rooms)	
	Vertical height diff. between O.U. and I.U.	m	Max. 15 (Outdoor unit is higher) Max. 15 (Outdoor unit is lower)	
Height difference of the indoor units	m	Max. 25		
Recommended breaker size	A		25	
L.R.A. (Locked rotor ampere)	A		5	
Interconnecting wires	Size x Core number		1.5mm ² x 4 cores (Including earth cable)	
	Connecting method		Terminal block (Screw fixing type)	
IP number			IPX4	
Standard accessories			Union : (φ 9.52→ φ 12.7) x 2, Installation sheet, Elbow, Grommet	
Indoor unit to be combined			SRK20,25,35,50,60ZSX-W(-WB,-WT) SRK20,25,35,50ZS-W(-WB,-WT) SKM20,25,35ZSP-W, SRR25,35ZM-W, SRR50,60ZS-W FDTC25,35,50,60VH, FDE50VH, FDUM50VH	
Number of connectable indoor units			Min. 2 - Max. 3	
Total of indoor units	kW		Max. 11	

Notes (1) The data are measured at the following conditions. The pipe length is 5m.

Operation	Indoor air temperature		Outdoor air temperature		Standards
	DB	WB	DB	WB	
Cooling	27°C	19°C	35°C	24°C	ISO5151-T1
Heating	20°C	—	7°C	6°C	ISO5151-H1
Heating (H2)	20°C	—	2°C	1°C	ISO5151-H2

- (2) This air-conditioner is manufactured and tested in conformity with the ISO.
- (3) Sound level indicates the value in an anechoic chamber.
During operation these values are somewhat higher due to ambient conditions.
- (4) Select the breaker size according to the own national standard.

RWC000Z338

1.2 Exterior dimensions

Models SCM50ZS-W, 60ZS-W

Notes

- (1) The unit must not be surrounded by walls on the four sides.
- (2) The unit must be fixed with anchor bolts. An anchor bolt must not protrude more than 15mm.
- (3) If the unit is installed in the location where there is a possibility of strong winds, place the unit such that the direction of air from the outlet gets perpendicular to the wind direction.
- (4) Leave 200mm or more space above the unit.
- (5) The wall height on the outlet side should be 1200mm or less.
- (6) The model name label is attached on the right side of the unit.

Symbol	Content
A	Service valve connection (gas side) $\phi 9.52$ (3 / 8") (Flare)
B	Service valve connection (liquid side) $\phi 6.35$ (1 / 4") (Flare)
C	Pipe / cable draw-out hole
D	Drain discharge hole
E	Anchor bolt hole $\phi 20 \times 2$ places M10-12x4 places

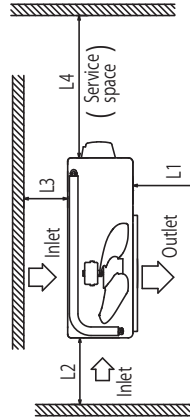
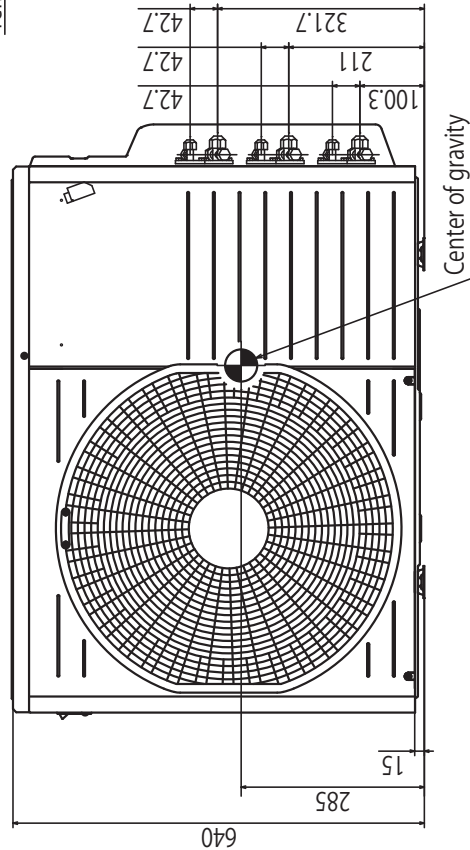
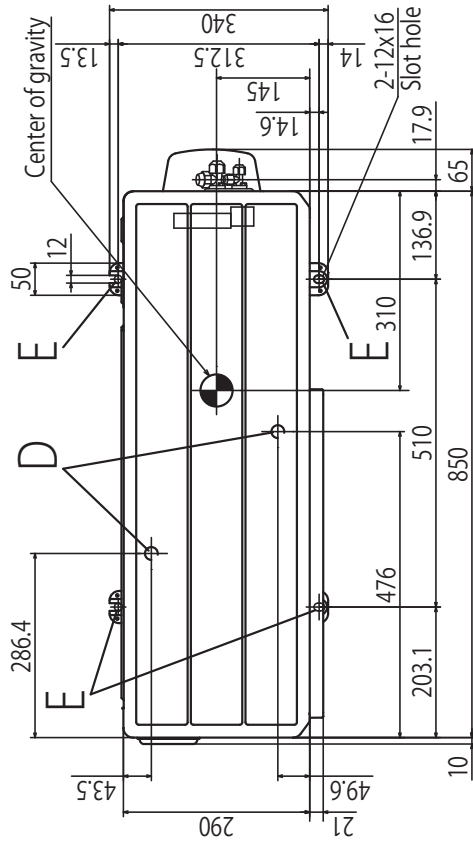

Minimum installation space

L1	Installation space
L2	600 or more
L3	100 or more
L4	100 or more
	No obstacles (Service space or electrical parts)

Unit:mm

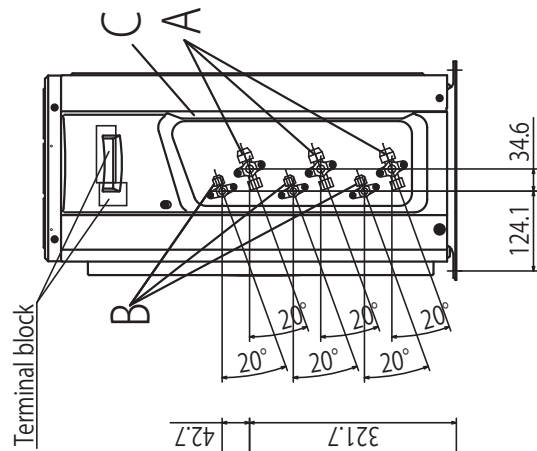

1.3 Electrical wiring Models SCM50ZS-W, 60ZS-W

Item	Description	Item	Description
CN20S	Connector	20S	4 Way valve (coil)
CN20V		CM	Compressor motor
CNA		EEV A, EEV B	Electric expansion valve (coil)
CNB		EEV C	
CNC		FMo	Fan motor
CNFAN		L	Reactor
CNEEV1		TB1, TB2	Terminal block
CNEEV3		TH1	Heat exchanger sensor 1
CNMAIN		TH2	Outdoor air temp. sensor
CNTH		TH3	Discharge pipe temp. sensor
CNSUB	TH4	Suction pipe temp. sensor	
		TH5	Heat exchanger sensor 2

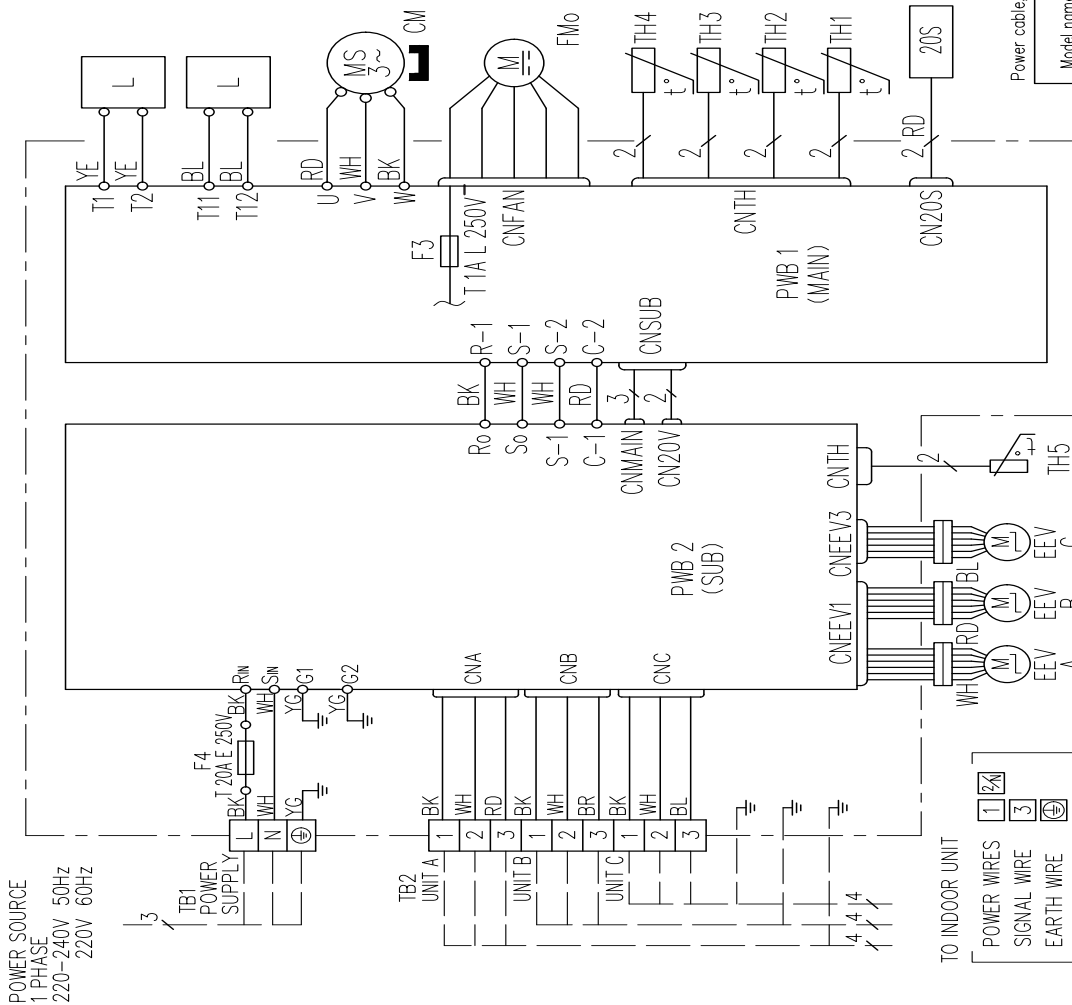

Mark	Color	Mark	Color
BK	Black	YE	Yellow
RD	Red	YG	Yellow/Green
WH	White	BR	Brown
BL	Blue		

Power cable, indoor-outdoor connecting wires

Model name	MAX running current (A)	Power cable wire size x number*	Power cable length (m)	Connecting cable wire size x number*
SCM50ZS-W SCM60ZS-W	15	2.5mm ² x 3	17	1.5mm ² x 4

- * The wire numbers include Earth wire (Yellow/Green)
- Switchgear or Circuit breaker capacity should be chosen according to national or regional electricity regulations.
- The power cable specifications are based on the assumption that a metal or plastic conduit is used with no more than three cables contained in a conduit and a voltage drop is 2%. For an installation falling outside of these conditions, please follow the national or regional electricity regulations.

1.4 Noise level

(1) Sound power level
Model SCM50ZS-W

Noise Level	Cooling	62 dB(A)
	Heating	64 dB(A)

Condition	ISO15042 T1/H1
Mode	Rated capacity value

x Cooling, ○ — Heating

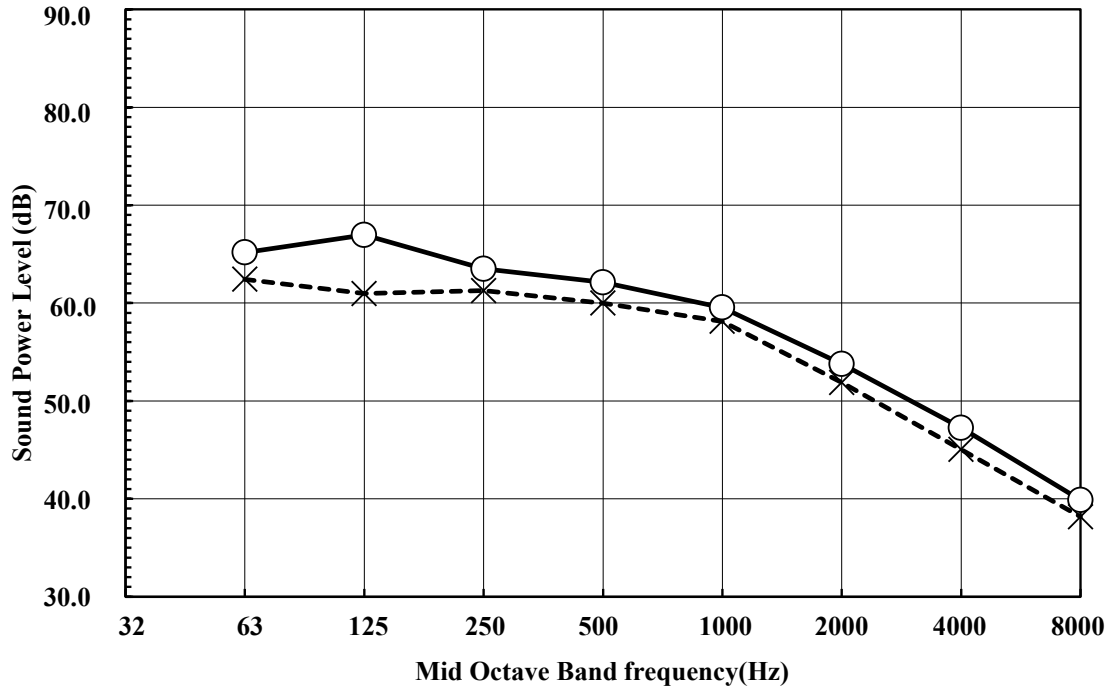

Model SCM60ZS-W

Noise Level	Cooling	62 dB(A)
	Heating	64 dB(A)

Condition	ISO15042 T1/H1
Mode	Rated capacity value

x Cooling, ○ — Heating

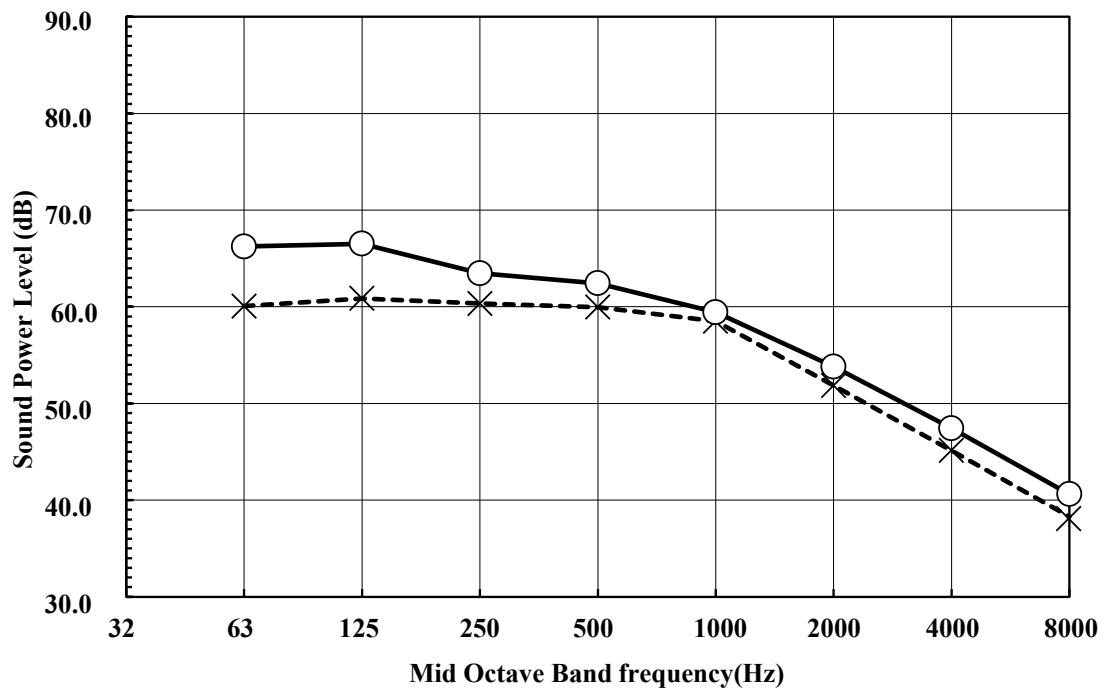

(2) Sound pressure level

(a) Rated capacity value

Model SCM50ZS-W

Noise Level	Cooling	49 dB(A)
	Heating	52 dB(A)

Condition	ISO15042 T1/H1
Mode	Rated capacity value

x Cooling, ○ — Heating

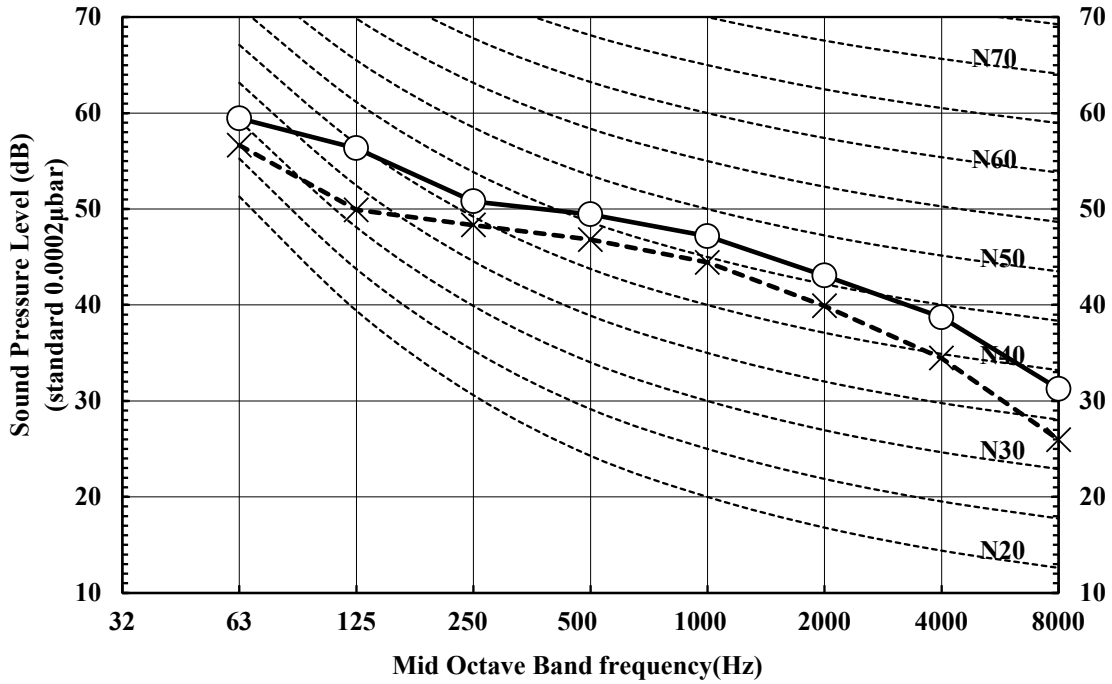

Model SCM60ZS-W

Noise Level	Cooling	50 dB(A)
	Heating	52 dB(A)

Condition	ISO15042 T1/H1
Mode	Rated capacity value

x Cooling, ○ — Heating

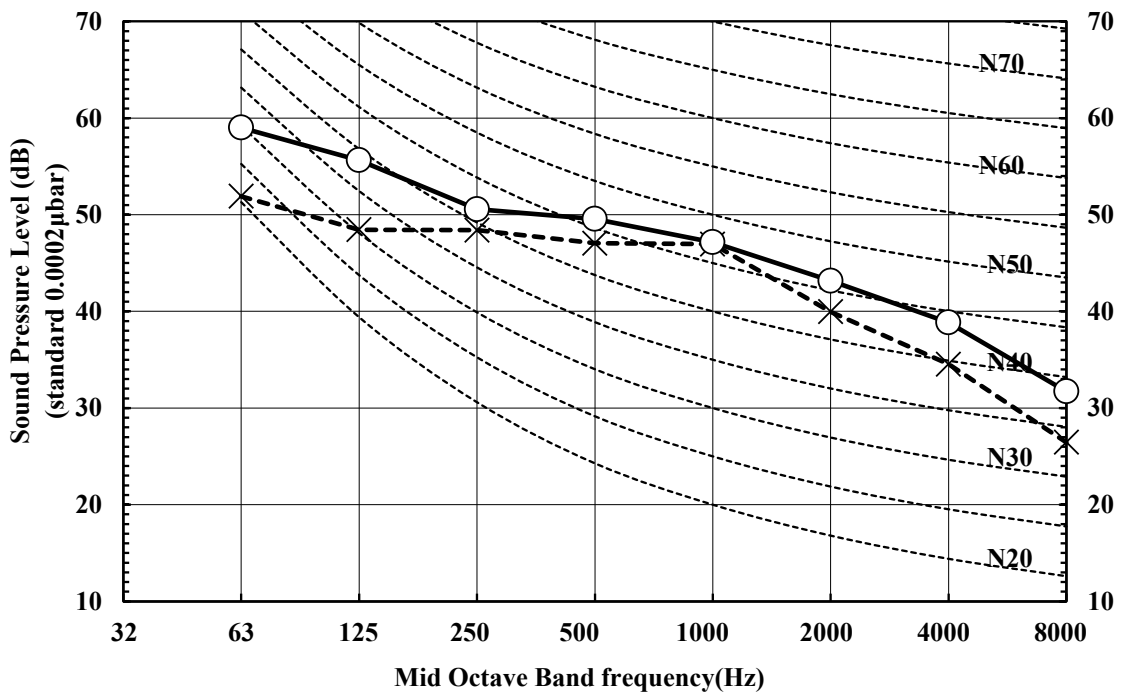

(b) Silent mode

Model SCM50ZS-W

Noise Level	Cooling	43 dB(A)
	Heating	44 dB(A)

Condition	ISO15042 T1/H1
Mode	Silent

x Cooling, O — Heating

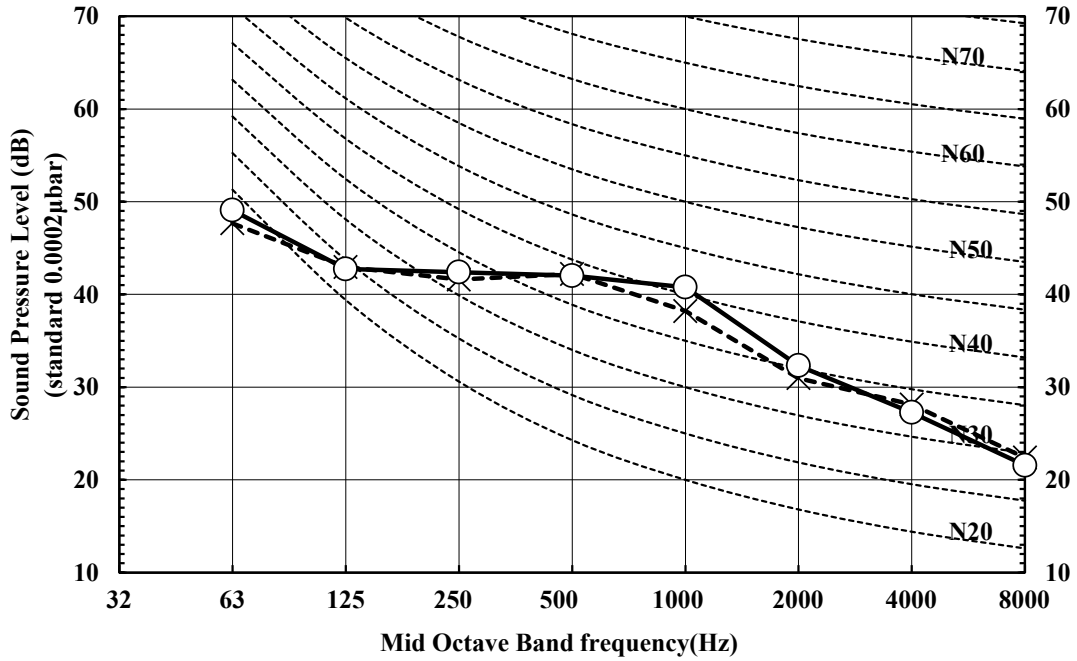

Model SCM60ZS-W

Noise Level	Cooling	43 dB(A)
	Heating	44 dB(A)

Condition	ISO15042 T1/H1
Mode	Silent

x Cooling, O — Heating

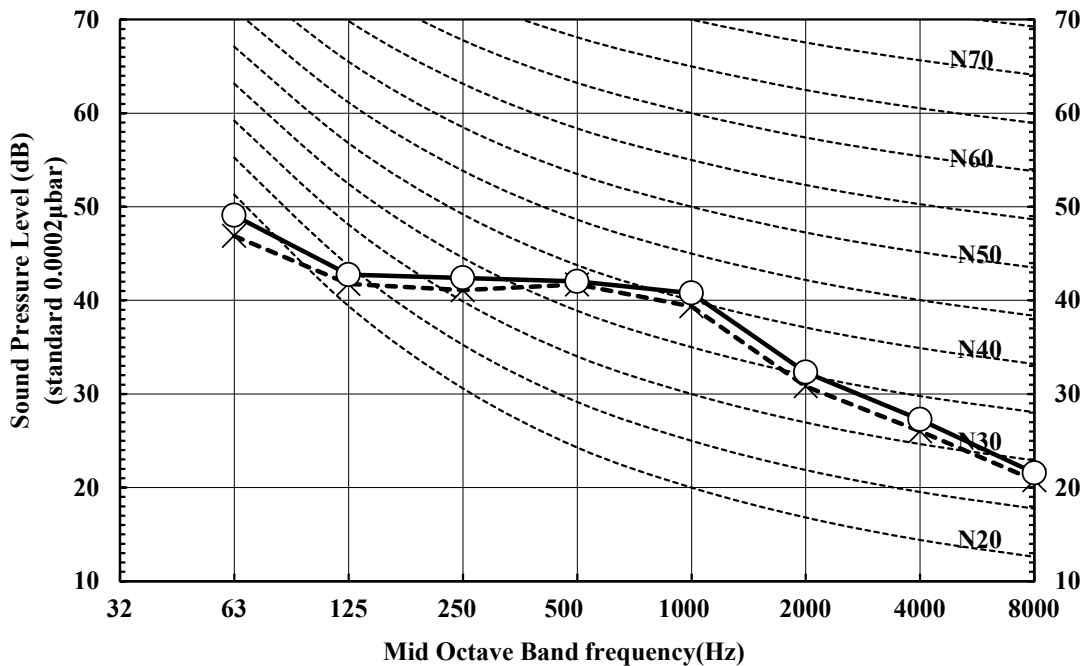

RPC012A853

1.5 Application data

Models SCM50ZS-W, 60ZS-W

Model SCM50,60ZS-W
R32 REFRIGERANT USED

• This installation manual deals with an outdoor unit installation only. For an indoor unit installation, refer to page 82.

NOTE This model requires a minimum of 2 indoor units.

SAFETY PRECAUTIONS

- Before installation, read the "SAFETY PRECAUTIONS" carefully and strictly follow it during the installation work in order to protect yourself.
- The precautionary items mentioned below are distinguished into two levels, **WARNING** and **CAUTION**.
 - WARNING** Indicates a potentially hazardous situation which, if not avoided, can result in serious consequences such as death or severe injury.
 - CAUTION** Indicates a potentially hazardous situation which, if not avoided, can result in personal injury or property damage.
- Both mention the important items to protect your health and safety. Therefore, strictly follow them by any means.
- Be sure to confirm no operation problem on the equipment after completing the installation. If unusual noise can be heard during the test run, consult the dealer.
- Be sure to explain the operating methods as well as the maintenance methods of this equipment to the user according to the user's manual.
- Be sure to keep the installation manual together with user's manual at a place where it is easily accessible to the user any time. Moreover, ask the user to hand the manuals to a new user, whenever required.



WARNING

- **Be sure to use only for residential purpose.**
If this unit is installed in inferior environment such as machine shop, vehicle (like ship), warehouse, etc., it can malfunction.
- **Installation must be carried out by the qualified installer completely in accordance with the installation manual.**
Installation by non qualified person or incorrect installation can cause serious troubles such as water leak, electric shock, fire and personal injury.
- **Be sure to wear protective goggles and gloves while performing installation work.**
Improper safety measures can result in personal injury.
- **Use the original accessories and the specified components for the installation.**
Using parts other than those prescribed may cause water leak, electric shock, fire and personal injury.
- **Do not install the unit near the location where leakage of flammable gases can occur.**
If leaked gases accumulate around the unit, it can cause fire resulting in property damage and personal injury.
- **When installing the unit in small rooms, make sure that refrigerant density does not exceed the limit (Reference: ISO5149) in the event of leakage.**
If refrigerant density exceeds the limit, consult the dealer and install the ventilation system. Otherwise lack of oxygen can occur resulting in serious accident.
- **Install the unit in a location where unit will remain stable, horizontal and free of any vibration transmission.**
Unsuitable installation location can cause the unit to fall resulting in material damage and personal injury.
- **Do not run the unit with removed panels or protections.**
Touching rotating equipments, hot surfaces or high voltage parts can cause personal injury due to entrapment, burn or electric shock.
- **This unit is designed specifically for R32.**
Using any other refrigerant can cause unit failure and personal injury.
- **Do not vent R32 into atmosphere.**
R32 is a fluorinated greenhouse gas with a Global Warming Potential (GWP) = 675.
- **Make sure that no air enters the refrigerant circuit when the unit is installed and removed.**
If air enters the refrigerant circuit, the pressure in the refrigerant circuit will become too high, which can cause burst and personal injury.
- **Be sure to use the prescribed pipes, flare nuts and tools for R32 or R410A.**
Using existing parts (for R22 or R407C) can cause refrigerant circuit burst resulting in unit failure and personal injury.
- **Be sure to connect both liquid and gas connecting pipes properly before operating the compressor.**
Do not open the liquid and gas operation valves before completing piping work, and evacuation.
If the compressor is operated when connecting pipes are not connected and operation valves are open, air can be sucked into the refrigerant circuit which can cause anomalous high pressure resulting in burst or personal injury.
- **Be sure to tighten the flare nuts to specified torque using the torque wrench.**
Tightening flare nuts with excess torque can cause burst and refrigerant leakage after a long period.
- **During pump down work, be sure to stop the compressor before closing operation valves and removing connecting pipes.**
If the connecting pipes are removed when the compressor is in operation and operation valves are open, air can be sucked into the refrigerant circuit which can cause anomalous high pressure resulting in burst or personal injury.
- **In the event of refrigerant leakage during installation, be sure to ventilate the working area properly.**
If the refrigerant comes into contact with naked flames, poisonous gases will be produced.
- **Electrical work must be carried out by the qualified electrician, strictly in accordance with national or regional electricity regulations.**
Incorrect installation can cause electric shock, fire or personal injury.
- **Make sure that earth leakage breaker and circuit breaker of appropriate capacities are installed.**
Circuit breaker should be able to disconnect all poles under over current. Absence of appropriate breakers can cause electric shock, personal injury or property damage.
- **Be sure to switch off the power source in the event of installation, maintenance or service.**
If the power source is not switched off, there is a risk of electric shock, unit failure or personal injury.
- **Be sure to tighten the cables securely in terminal block and relieve the cables properly to prevent overloading the terminal blocks.**
Loose connections or cable mountings can cause anomalous heat production or fire.
- **Do not process, splice or modify the power cable, or share the socket with other power plugs.**
Improper power cable or power plug can cause fire or electric shock due to poor connection, insufficient insulation or over-current.
- **Do not perform any change in protective device or its setup condition yourself.**
Changing protective device specifications can cause electric shock, fire or burst.
- **Be sure to clamp the cables properly so that they do not touch any internal component of the unit.**
If cables touch any internal component, it can cause overheating and fire.
- **Be sure to install service cover properly.**
Improper installation can cause electric shock or fire due to intrusion of dust or water.
- **Be sure to use the prescribed power and connecting cables for electrical work.**
Using improper cables can cause electric leak or fire.
- **This appliance must be connected to main power source by means of a circuit breaker or switch with a contact separation of at least 3 mm.**
Improper electrical work can cause unit failure or personal injury.
- **Be sure to connect the power source cable with power source properly.**
Improper connection can cause intrusion of dust or water resulting in electric shock or fire.

CAUTION

- **Take care when carrying the unit by hand.**
If the unit weight is more than 20 kg, it must be carried by two or more persons. Do not carry the unit by the plastic straps. Always use the carry handle.
- **Do not install the outdoor unit in a location where insects and small animals can inhabit.**
Insects and small animals can enter the electrical parts and cause damage resulting in fire or personal injury. Instruct the user to keep the surroundings clean.
- **If the outdoor unit is installed at height, make sure that there is enough space for installation, maintenance and service.**
Insufficient space can result in personal injury due to falling from the height.
- **Do not install the unit near the location where neighbours are bothered by noise or air generating from the unit.**
It can affect surrounding environment and cause a claim.
- **Do not install in the locations where unit is directly exposed to corrosive gases (like sulphide gas, chloride gas), sea breeze or salty atmosphere.**
It can cause corrosion of heat exchanger and damage to plastic parts.
- **Do not install the unit close to the equipments that generate electromagnetic waves and/or high-harmonic waves.**
Equipment such as inverters, standby generators, medical high frequency equipments and telecommunication equipments can affect the system, and cause malfunctions and breakdowns. The system can also affect medical equipment and telecommunication equipment, and obstruct its function or cause jamming.
- **Do not install the unit in the locations where:**
 - There are heat sources nearby.
 - Unit is directly exposed to rain or sunlight.
 - There is any obstacle which can prevent smooth air circulation from inlet and outlet side of the unit.
 - Unit is directly exposed to oil mist and steam such as kitchen.
 - Chemical substances like ammonia (organic fertilizer), calcium chloride (snow melting agent) and acid (sulfurous acid etc.), which can harm the unit, will generate or accumulate.
 - Drain water can not be discharged properly.
 - TV set or radio receiver is placed within 1 m.
 - Height above sea level is more than 1000 m.
 - It can cause performance degradation, corrosion and damage of components, unit malfunction and fire.
- **Dispose of all packing materials properly.**
Packing materials contain nails and wood which can cause personal injury. Keep the polybag away from children to avoid the risk of suffocation.
- **Do not put anything on the outdoor unit.**
Object may fall causing property damage or personal injury.
- **Do not touch the aluminum fin of the outdoor unit.**
Aluminium fin temperature is high during heating operation. Touching fin can cause burn.
- **Do not touch any refrigerant pipe with your hands when the system is in operation.**
During operation the refrigerant pipes become extremely hot or extremely cold depending on the operating condition. Touching pipes can cause personal injury like burn (hot/cold).
- **Install isolator or disconnect switch on the power source wiring in accordance with the local codes and regulations.**
The isolator should be locked in OFF state in accordance with EN60204-1.

1. ACCESSORIES AND TOOLS

Standard accessories (Supplied with outdoor unit)		Q'ty	Locally procured parts		Tools for installation work		
(1)	Drain grommet 	1	(a)	Anchor bolt (M10-M12) × 4 pcs	Plus headed driver	Spanner wrench	Vacuum pump*
(2)	Drain elbow 	1	(b)	Putty	Knife	Torque wrench [14.0-62.0 N·m(1.4-6.2 kgf·m)]	Gauge manifold *
(3)	Variable diameter joint ø9.52→ø12.7	SCM50	(c)	Electrical tape	Saw	Wrench key (Hexagon) [4 mm]	Charge hose *
		SCM60	(d)	Connecting pipe	Tape measure	Flaring tool set *	Vacuum pump adapter* (Anti-reverse flow type)
			(e)	Connecting cable	Pipe cutter	Flare adjustment gauge	Gas leak detector *
			(f)	Power cable			
			(g)	Clamp and screw (for finishing work)			

*Designed specifically for R32 or R410A

2. OUTDOOR UNIT INSTALLATION

Note as a unit designed for R32

- Do not use any refrigerant other than R32. R32 will rise to pressure about 1.6 times higher than that of a conventional refrigerant. A cylinder containing R32 has a light blue indication mark on the top.
- Do not use a charge cylinder. The use of a charge cylinder will cause the refrigerant composition to change, which results in performance degradation.
- In charging refrigerant, always take it out from a cylinder in the liquid phase.
- All indoor units must be models designed exclusively for R32. Check connectable indoor unit models in a catalog, etc. (A wrong indoor unit, if connected into the system, will impair proper system operation)

1. Haulage

- Always carry or move the unit with two or more persons.
 - The right hand side of the unit as viewed from the front (outlet side) is heavier.
- A person carrying the right hand side must take care of this fact. A person carrying the left hand side must hold the handle provided on the front panel of the unit with his right hand and the corner column section of the unit with his left hand.

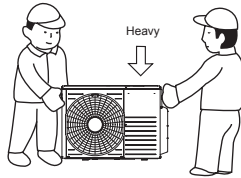

CAUTION

When a unit is hauled, take care of its gravity center position which is shifted towards right hand side. If the unit is not hauled properly, it can go off balance and fall resulting in serious injury.

2. Selecting the installation location

Select the suitable installation location where:

- Unit will be stable, horizontal and free of any vibration transmission.
- There is no obstacle which can prevent smooth air circulation from inlet and outlet side of the unit.
- There is enough space for service and maintenance of unit.
- Neighbours are not bothered by noise or air generating from the unit.
- Outlet air of the unit does not blow directly to animals or plants.
- Drain water can be discharged properly.
- There is no risk of flammable gas leakage.
- There are no other heat sources nearby.
- Unit is not directly exposed to rain or sunlight.
- Unit is not directly exposed to oil mist and steam.
- Chemical substances like ammonia (organic fertilizer), calcium chloride (snow melting agent) and acid (sulfurous acid etc.), which can harm the unit, will not generate or accumulate.
- Unit is not directly exposed to corrosive gases (like sulphide gas, chloride gas), sea breeze or salty atmosphere.
- No TV set or radio receiver is placed within 1 m.
- Unit is not affected by electromagnetic waves and/or high-harmonic waves generated by other equipments.
- Strong wind does not blow against the unit outlet.
- Heavy snowfalls do not occur (if installed, provide proper protection to avoid snow accumulation).

NOTE

If the unit is installed in the area where there is a possibility of strong wind or snow accumulation, the following measures are required.

(1) Location of strong wind

- Place the unit with its outlet side facing the wall.
- Place the unit such that the direction of air from the outlet gets perpendicular to the wind direction.



(2) Location of snow accumulation

- Install the unit on the base so that the bottom is higher than snow cover surface.
- Install the unit under eaves or provide the roof on site.

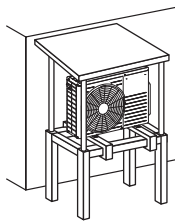

3. Installation space

- There must be 1 m or larger space between the unit and the wall in at least 1 of the 4 sides. Walls surrounding the unit from 4 sides is not acceptable. The wall height on the outlet side should be 1200 mm or less. Refer to the following figure and table for details.

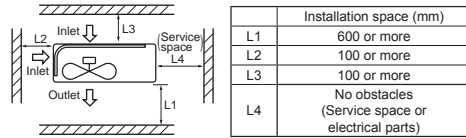

NOTE

When more than one unit are installed side by side, provide a 250 mm or wider interval between them as a service space.

CAUTION

When more than one unit are installed in parallel directions, provide sufficient inlet space so that short-circuiting may not occur.

4. Drain piping work (If necessary)

Carry out drain piping work by using a drain elbow and a drain grommet supplied separately as accessories if condensed water needs to be drained out.

- Install drain elbow and drain grommet.
- Seal around the drain elbow and drain grommet with putty or adequate caulking material.

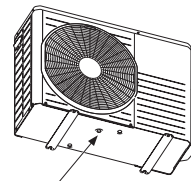

Do not put a grommet on this hole.

This is a supplementary drain hole to discharge drain water, when a large amount of it is gathered.

CAUTION

Do not use drain elbow and drain grommet if there is a possibility to have several consecutive days of sub zero temperature. (There is a risk of drain water freezing inside and blocking the drain.)

5. Installation

- Install the unit on a flat level base.
- While installing the unit, keep space and fix the unit's legs with 4 anchor bolts as shown in the figure below. The protrusion of an anchor bolt from the foundation surface must be kept within 15 mm.

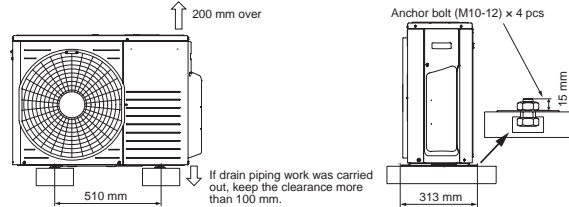

CAUTION

- Install the unit properly so that it does not fall over during earthquake, strong wind, etc.
- Make sure that unit is installed on a flat level base. Installing unit on uneven base may result in unit malfunction.

3. PREPARATION FOR WORK

1. Removing service cover

Remove the screw. Slide service cover downwards and remove it.

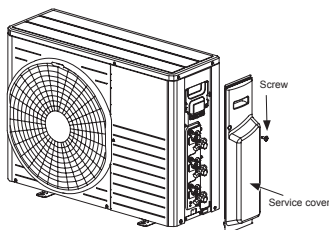

NOTE

Variable diameter joint is inside service cover. Remove it at a safe place before carrying in the installation location to prevent unexpected fall of parts.

2. Removing terminal cover

Remove the screw and take out terminal cover.

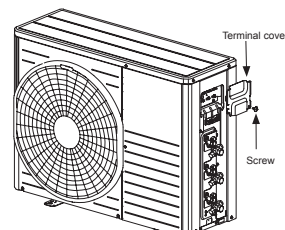

4. CONNECTING PIPING WORK

1. Restrictions on unit installation

Abide by the following restrictions on unit installation. Improper installation can cause compressor failure or performance degradation.

Piping length	One indoor unit MAX 25 m All indoor unit MAX 40 m
Height difference	

2. Preparation of connecting pipe

2.1 Selecting connecting pipe

Select connecting pipe according to the following table.

Indoor unit	Model 20/25/35	Model 40/50/60
Gas pipe	ø9.52	ø12.7
Liquid pipe	ø6.35	ø6.35

- Pipe wall thickness must be greater than or equal to 0.8 mm.
- Pipe material must be O-type (Phosphorus deoxidized seamless copper pipe ICS 23.040.15, ICS 77.150.30).

2.2 Cutting connecting pipe

- (1) Cut the connecting pipe to the required length with pipe cutter.
- (2) Hold the pipe downward and remove the burrs. Make sure that no foreign material enters the pipe.
- (3) Cover the connecting pipe ends with the tape.

3. Piping work

Check that both liquid and gas operation valves are fully closed. Carry out the piping work with operation valves fully closed.

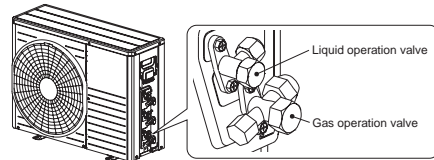

3.1 Flaring pipe

- (1) Take out flare nuts from the operation valves of outdoor unit. If a 4.0, 5.0, 6.0 kW class indoor unit (gas side pipe ø12.7) is going to be connected to the operation valves (ø9.52), variable joints available as accessories must be applied to the gas side operation valves. Securely fit the copper packing between the operation valve and the variable diameter joint to prevent shifting. Engage flare nuts onto connecting pipes.

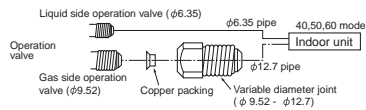

- (2) Flare the pipes according to table and figure shown below. Flare dimensions for R32 are different from those for conventional refrigerant. Although it is recommended to use the flaring tools designed specifically for R32, conventional flaring tools can also be used by adjusting the dimension B with a flare adjustment gauge.

	Copper pipe outer diameter	A		B [Rigid (clutch) type]	
	ø6.35	9.1		R32 or R410A	Conventional
	ø9.52	13.2		0-0.5	1.0-1.5
	ø12.7	16.6			

3.2 Connecting pipes

- (1) Connect pipes on both liquid and gas sides.

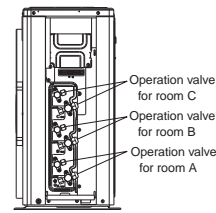

- (2) Tighten nuts to specified torque shown in the table below.

Operation valve size (mm)	Tightening torque (N·m)
ø6.35 (1/4")	14-18
ø9.52 (3/8")	34-42
ø12.7 (1/2")	49-61

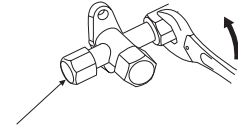

Do not hold the valve cap area with a spanner

CAUTION

- Do not apply refrigerating machine oil to the flared surface. It can cause refrigerant leakage.
- Do not apply excess torque to the flared nuts. The flared nuts may crack resulting in refrigerant leakage.

4. Evacuation

- (1) Connect vacuum pump to gauge manifold. Connect charge hose of gauge manifold to a service port of outdoor unit.
- (2) Run the vacuum pump for at least one hour after the vacuum gauge shows -0.1 MPa (-76 cm Hg).
- (3) Confirm that the vacuum gauge indicator does not rise even if the system is left for 15 minutes or more. Vacuum gauge indicator will rise if the system has moisture left inside or has a leakage point. Check the system for the leakage point. If leakage point is found, repair it and return to (1) again.
- (4) Close the Handle Lo and stop the vacuum pump. Keep this state for a few minutes to make sure that the compound pressure gauge pointer does not swing back.
- (5) Remove valve caps from liquid operation valve and gas operation valve.
- (6) Turn the liquid operation valve's rod 90 degree counterclockwise with a hexagonal wrench key to open valve. Close it after 5 seconds, and check for gas leakage. Using soapy water, check for gas leakage from indoor unit's flare and outdoor unit's flare and valve rods. Wipe off all the water after completing the check.
- (7) Disconnect charging hose from gas operation valve's service port and fully open liquid and gas operation valves. (Do not attempt to turn valve rod beyond its stop.)
- (8) Tighten operation valve caps and service port cap to the specified torque shown in the table below.

Operation valve size (mm)	Operation valve cap tightening torque (N·m)	Service port cap tightening torque (N·m)
ø6.35 (1/4")	20-30	10-12
ø9.52 (3/8")		
ø12.7 (1/2")	25-35	

- (9) Repeat the above steps (1) to (8) for all connected indoor units.

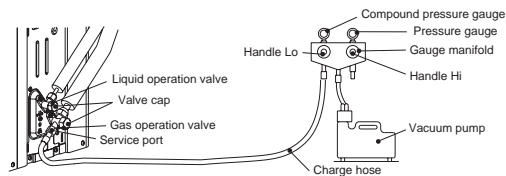

CAUTION

To prevent vacuum pump oil from entering into the refrigerant system, use a counterflow prevention adapter.

5. ELECTRICAL WIRING WORK

WARNING

- Make sure that all the electrical work is carried out in accordance with the national or regional electrical standards.
- Make sure that the earth leakage breaker and circuit breaker of appropriate capacities are installed (Refer to the table given below).
- Do not turn on the power until the electrical work is completed.
- Do not use a condensive capacitor for power factor improvement under any circumstances. (It does not improve power factor. Moreover, it can cause an abnormal overheating accident).

Breaker specifications

Model	Phase	Earth leakage breaker	Circuit breaker
SCM50/60	Single phase	Leakage current: 30 mA, 0.1sec or less	Over current: 25 A

Main fuse specification

Model	Specification	Parts No.	Code on LABEL, WIRING
SCM50/60	250 V 20 A	SSA564A136A	F4

1. Preparing cable

(1) Selecting cable

Select the power source cable and connecting cable in accordance with the specifications mentioned below.

(a) Power source cable

- 3-core* 2.5 mm² or more, conformed with 60245 IEC57
- When selecting the power source cable length, make sure that voltage drop is less than 2 %.
- If the wire length gets longer, increase the wire diameter.

(b) Connecting cable

- 4-core* 1.5 mm², conformed with 60245 IEC57
- * 1 Earth wire is included (Yellow/Green).

- (2) Arrange each wire length as shown below.

Make sure that each wire is stripped 10 mm from the end.

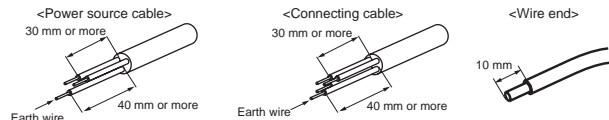

- (3) Attach round crimp-type terminal to each wire as shown in the below.

Select the size of round crimp-type terminal after considering the specifications of terminal block and wire diameter.

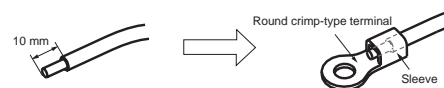

CAUTION

Power source cable and connecting cable must conform to the specifications mentioned in the manual. Using cables with wrong specifications may result in unit malfunction.

5. ELECTRICAL WIRING WORK

2. Connecting cable

- (1) Remove the service cover and the terminal cover.
- (2) Connect the cables according to the instructions and figures given below.
 - (a) Connect the earth wire of power source cable. An earth wire must be connected before connecting the other wires of power source cable. Keep the earth wire longer than the remaining two wires of power source cable.
 - (b) Connect the remaining two wires (N and L) of power source cable.
 - (c) Connect the wires of connecting cables. Make sure that for each wire, outdoor and indoor side terminal numbers match. Terminal number A of the outdoor unit is used for A indoor unit and terminal number B for B indoor unit respectively. Earth wire shall be Yellow/Green (Y/G) in color and longer than other wires for safety reason.
- (3) Fasten the cables properly with cable clamps so that no external force may work on terminal connections. Moreover, make sure that cables do not touch the piping, etc. When cables are connected, make sure that all electrical components within the electrical component box are free of loose connector coupling or terminal connection.

<Circuit diagram>

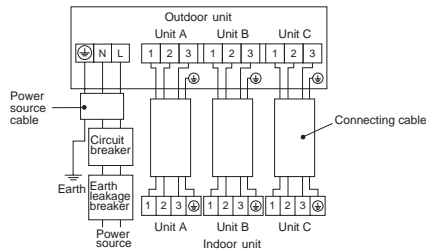

View of terminal block

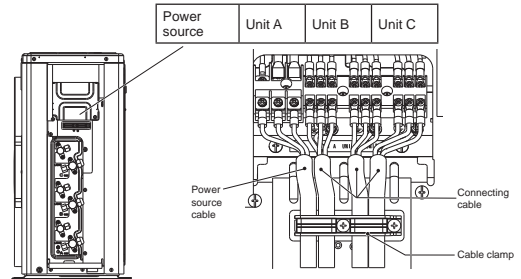

6. FINISHING WORK

NOTE

- Make sure to match the piping and wiring from each unit to the outdoor unit.
- Be careful because if connections are wrong, normal operation cannot be achieved and may damage the compressor.

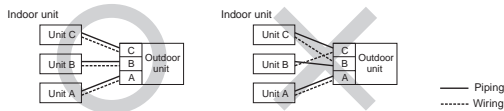

1. Heating and condensation prevention

- (1) Dress the connecting pipes (both liquid and gas pipes) with insulation to prevent it from heating and dew condensation. Use the heat insulating material which can withstand 120 °C or higher temperature. Make sure that insulation is wrapped tightly around the pipes and no gap is left between them.
- (2) Wrap the refrigerant pipings of indoor unit with indoor unit heat insulation using tape.
- (3) Cover the flare-connected joints (indoor side) with the indoor unit heat insulation and wrap it with an insulation pad (standard accessory provided with indoor unit).
- (4) Wrap the connecting pipes, connecting cable and drain hose with the tape.

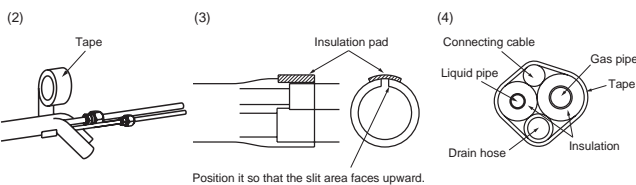

NOTE

Locations where relative humidity exceeds 70 %, both liquid and gas pipes need to be dressed with 20 mm or thicker heat insulation materials.

CAUTION

- Improper insulation can cause condensate (water) formation during cooling operation. Condensate can leak or drip causing damage to household property.
- Poor heat insulating capacity can cause pipe outer surface to reach high temperature during heating operation. It can cause cable deterioration and personal injury.

2. Finishing work

- (1) Make sure that the exterior portion of connecting pipes, connecting cable and drain hose is wrapped properly with tape. Shape the connecting pipes to match with the contours of the pipe assembly route.
- (2) Fix the pipe assembly with the wall using clamps and screws. Pipe assembly should be anchored every 1.5 m or less to isolate the vibration.
- (3) Install the terminal cover and the service cover securely. Water may enter the unit if service cover is not installed properly, resulting in unit malfunction and failure.

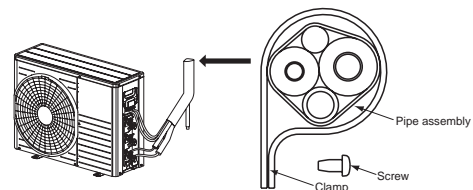

CAUTION

Make sure that the connecting pipes do not touch the components within the unit. If pipes touch the internal components, it may generate abnormal sounds and/or vibrations.

7. PUMP DOWN

- (1) Connect charge hose of gauge manifold to a service port of outdoor unit.
- (2) Close the liquid operation valves for all connected indoor units with hexagonal wrench key.
- (3) Fully open the gas operation valves with hexagonal wrench key.
- (4) Carry out forced cooling operation for all connected indoor units (For forced cooling operation procedure, refer to indoor unit installation manual).
- (5) When the low pressure gauge becomes 0.01 MPa, close the gas operation valves and stop forced cooling operation.

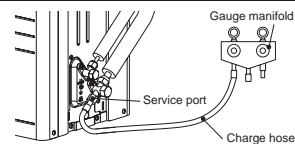

8. INSTALLATION TEST CHECK POINTS

After finishing the installation work, check the following points again before turning on the power. Conduct test run (Refer to indoor unit installation manual) and ensure that the unit operates properly.

Power source voltage complies with the rated voltage of air-conditioner.	
Earth leakage breaker and circuit breaker are installed.	
Power cable and connecting cable are securely fixed to the terminal block.	
Both liquid and gas operation valves are fully open.	
No gas leaks from the joints of the operation valves.	

Indoor and outdoor side pipe joints have been insulated.	
Drain hose (if installed) is fixed properly.	
Screw of the service cover is tightened properly.	
Piping and wiring from each unit to the outdoor unit are matched.	

3. PIPING SYSTEM

Models SCM50ZS-W, 60ZS-W

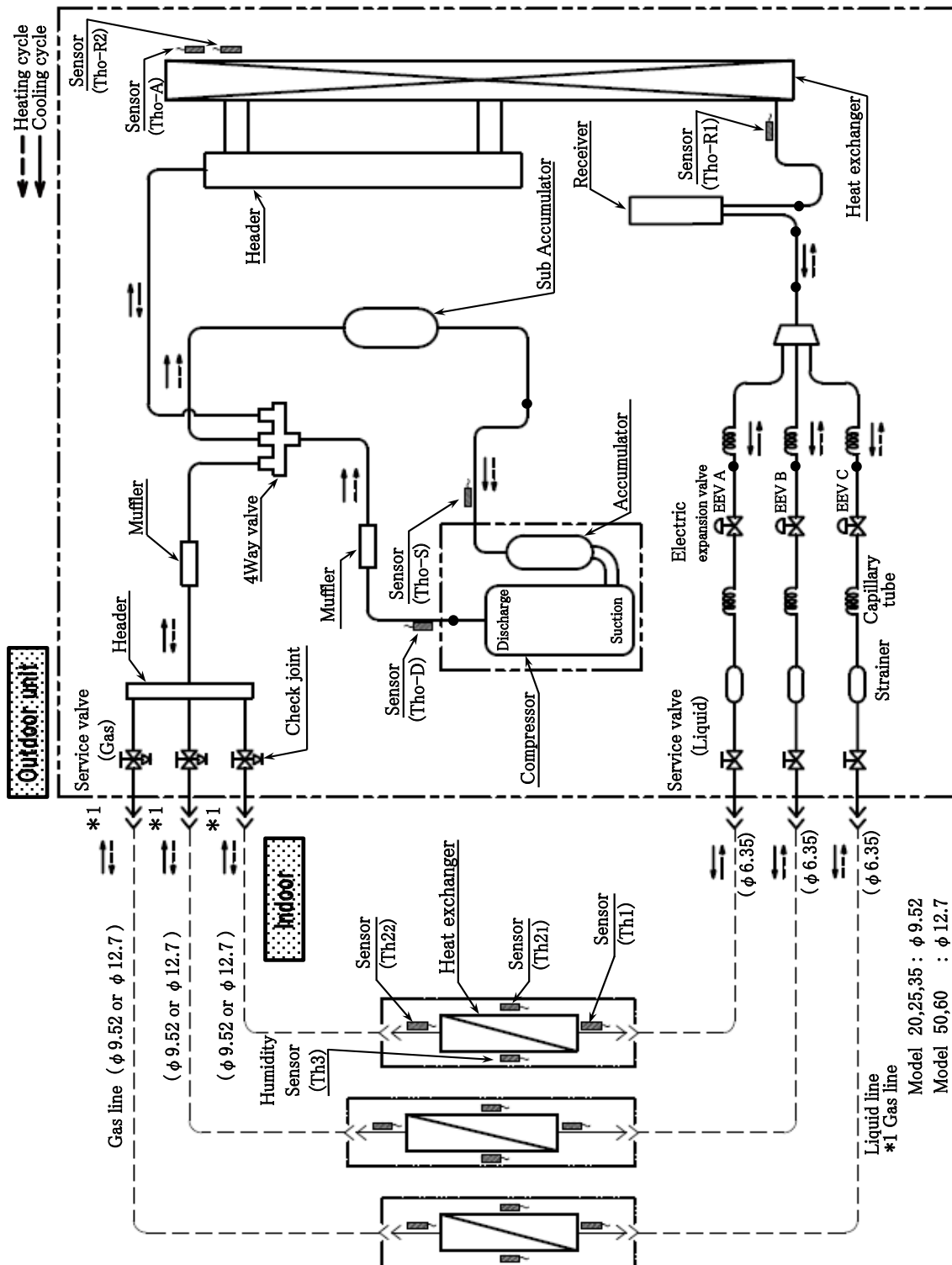

4. RANGE OF USAGE & LIMITATIONS

Item		Model	SCM50ZS-W	SCM60ZS-W
Indoor intake air temperature (Upper, lower limits)	Cooling		Approximately 18 to 32°C	
	Heating		Approximately 15 to 30°C	
Outdoor air temperature (Upper, lower limits)	Cooling		Approximately -15 to 46°C	
	Heating		Approximately -15 to 24°C	
Indoor units that can be used in combination	Number of connected units		2 to 3 units	
	Total of indoor Units (class kW)		4.0-8.5kW	4.0-11.0kW
Total length for all rooms			Max. 40m	
Length for one indoor unit			Max. 25m	
Difference in height between indoor and outdoor units	When indoor unit is above outdoor unit (A)		Max. 15m	
	When indoor unit is below outdoor unit (B)		Max. 15m	
Difference in height between indoor units (C)			Max. 25m	
Compressor stop/start frequency	1 cycle time		10 min. or more (from stop to stop or from start to start)	
	Stop time		3 min. or more	
Power source voltage	Voltage fluctuation		Within $\pm 10\%$ of rated voltage	
	Voltage drop during start		Within $\pm 15\%$ of rated voltage	
	Interval unbalance		Within $\pm 3\%$ of rated voltage	
Power cable length			17m ⁽¹⁾	

Note(1) The cable specifications are based on the assumption that a metal or plastic conduit is used with no more than three cables contained in a conduit and a voltage drop is 2%. For an installation falling outside of these conditions, please follow the internal cabling regulations. Adapt it to the regulation in effect in each country.

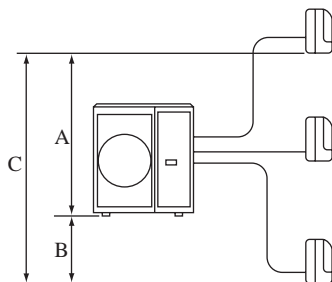

5. TABLE OF INDOOR UNIT COMBINATION

- The combinations of the indoor units is indicated by numbers. They are read as follows.
(Example) SRK20ZSX-W→20 SRK25ZSX-W→25
- The capacity of the indoor units is shown by rooms. If this exceeds the maximum capacity of the outdoor unit, the demand capacity will be proportionally distributed.
- If units are to be combined, use the table below to make the proper selection.

Number of connectable indoor units

	SCM50ZS-W,60ZS-W
MIN	2
MAX	3

(1) Model SCM50ZS-W

(a) In case of indoor unit SRK-ZSX-W models only

Cooling		Cooling capacity (kW)							Power consumption(W)			Standard current(A)		
		Indoor unit capacity (kW)				Total capacity (kW)			Min.	Standard	Max.	220V	230V	240V
		A	B	C	D	Min.	Standard	Max.						
1 unit	20	2.0	-	-	-	1.7	2.0	2.8	430	500	950	2.4	2.3	2.2
	25	2.5	-	-	-	1.7	2.5	3.4	430	680	1070	3.2	3.1	3.0
	35	3.5	-	-	-	1.7	3.5	3.9	430	1010	1230	4.7	4.5	4.3
	50	5.0	-	-	-	1.7	5.0	5.5	430	1530	2000	7.0	6.7	6.4
2 units	20+20	2.0	2.0	-	-	1.8	4.0	5.7	390	750	1750	3.5	3.3	3.2
	20+25	2.0	2.5	-	-	1.8	4.5	5.9	390	990	1910	4.6	4.4	4.2
	20+35	1.8	3.2	-	-	1.8	5.0	6.5	390	1110	2150	5.1	4.9	4.7
	20+50	1.4	3.6	-	-	1.8	5.0	6.5	390	1110	2150	5.1	4.9	4.7
	25+25	2.5	2.5	-	-	1.8	5.0	6.5	390	1110	2150	5.1	4.9	4.7
	25+35	2.1	2.9	-	-	1.8	5.0	6.5	390	1110	2150	5.1	4.9	4.7
	25+50	1.7	3.3	-	-	1.8	5.0	6.5	390	1110	2150	5.1	4.9	4.7
	35+35	2.5	2.5	-	-	1.8	5.0	6.5	390	1110	2150	5.1	4.9	4.7
3 units	20+20+20	1.7	1.7	1.7	-	2.1	5.0	7.1	350	1020	2150	4.7	4.5	4.3
	20+20+25	1.5	1.5	1.9	-	2.1	5.0	7.1	350	1020	2150	4.7	4.5	4.3
	20+20+35	1.3	1.3	2.3	-	2.1	5.0	7.1	350	1020	2150	4.7	4.5	4.3
	20+25+25	1.4	1.8	1.8	-	2.1	5.0	7.1	350	1020	2150	4.7	4.5	4.3
	20+25+35	1.3	1.6	2.2	-	2.1	5.0	7.1	350	1020	2150	4.7	4.5	4.3
	25+25+5	1.7	1.7	1.7	-	2.1	5.0	7.1	350	1020	2150	4.7	4.5	4.3
25+25+35	1.5	1.5	2.1	-	2.1	5.0	7.1	350	1020	2150	4.7	4.5	4.3	

Heating		Heating capacity (kW)							Power consumption (W)			Standard current (A)		
		Indoor unit capacity (kW)				Total capacity (kW)			Min.	Standard	Max.	220V	230V	240V
		A	B	C	D	Min.	Standard	Max.						
1 unit	20	3	-	-	-	1.0	3.0	3.7	320	780	1100	3.6	3.5	3.3
	25	3.4	-	-	-	1.0	3.4	4.2	320	950	1240	4.4	4.2	4.0
	35	4.5	-	-	-	1.0	4.5	5.0	320	1270	1490	5.9	5.6	5.4
	50	5.8	-	-	-	1.0	5.8	6.5	320	1710	2310	7.9	7.6	7.3
2 units	20+20	2.7	2.7	-	-	1.2	5.4	7.3	290	1050	2500	4.9	4.7	4.5
	20+25	2.6	3.3	-	-	1.2	5.9	7.3	290	1180	2500	5.5	5.2	5.0
	20+35	2.2	3.8	-	-	1.2	6.0	7.3	290	1200	2500	5.6	5.3	5.1
	20+50	1.7	4.3	-	-	1.2	6.0	7.3	290	1200	2500	5.6	5.3	5.1
	25+25	3.0	3.0	-	-	1.2	6.0	7.3	290	1200	2500	5.6	5.3	5.1
	25+35	2.5	3.5	-	-	1.2	6.0	7.3	290	1200	2500	5.6	5.3	5.1
	25+50	2.0	4.0	-	-	1.2	6.0	7.3	290	1200	2500	5.6	5.3	5.1
	35+35	3.0	3.0	-	-	1.2	6.0	7.3	290	1200	2500	5.6	5.3	5.1
3 units	20+20+20	2.57	2.57	2.57	-	1.4	6.0	7.5	270	1160	2500	5.4	5.1	4.9
	20+20+25	2.46	2.46	3.08	-	1.4	6.0	7.5	270	1160	2500	5.4	5.1	4.9
	20+20+35	2.24	2.24	3.92	-	1.4	6.0	7.5	270	1160	2500	5.4	5.1	4.9
	20+25+25	2.34	2.93	2.93	-	1.4	6.0	7.5	270	1160	2500	5.4	5.1	4.9
	20+25+35	2.10	2.63	3.68	-	1.4	6.0	7.5	270	1160	2500	5.4	5.1	4.9
	25+25+5	2.80	2.80	2.80	-	1.4	6.0	7.5	270	1160	2500	5.4	5.1	4.9
25+25+35	2.47	2.47	3.46	-	1.4	6.0	7.5	270	1160	2500	5.4	5.1	4.9	

(b) In case of indoor unit other models

Cooling		Cooling capacity (kW)							Power consumption(W)			Standard current(A)		
Indoor unit combination		Indoor unit capacity (kW)				Total capacity (kW)			Min.	Standard	Max.	220V	230V	240V
		A	B	C	D	Min.	Standard	Max.						
1 unit	20	2.0	-	-	-	1.7	2.0	2.7	430	530	900	2.5	2.4	2.3
	25	2.5	-	-	-	1.7	2.5	3.2	430	730	1070	3.4	3.3	3.1
	35	3.5	-	-	-	1.7	3.5	3.7	430	1120	1230	5.2	4.9	4.7
	50	5.0	-	-	-	1.7	5.0	5.3	430	1710	2000	7.9	7.5	7.2
2 units	20+20	2.0	2.0	-	-	1.8	4.0	5.6	390	950	1800	4.4	4.2	4.0
	20+25	2.0	2.5	-	-	1.8	4.5	5.8	390	1110	1980	5.1	4.9	4.7
	20+35	1.8	3.2	-	-	1.8	5.0	6.3	390	1350	2150	6.2	5.9	5.7
	20+50	1.4	3.6	-	-	1.8	5.0	6.3	390	1350	2150	6.2	5.9	5.7
	25+25	2.5	2.5	-	-	1.8	5.0	6.3	390	1350	2150	6.2	5.9	5.7
	25+35	2.1	2.9	-	-	1.8	5.0	6.3	390	1350	2150	6.2	5.9	5.7
	25+50	1.7	3.3	-	-	1.8	5.0	6.3	390	1350	2150	6.2	5.9	5.7
	35+35	2.5	2.5	-	-	1.8	5.0	6.3	390	1350	2150	6.2	5.9	5.7
3 units	35+50	2.1	2.9	-	-	1.8	5.0	6.3	390	1350	2150	6.2	5.9	5.7
	20+20+20	1.7	1.7	1.7	-	2.1	5.0	6.9	350	1120	2150	5.1	4.9	4.7
	20+20+25	1.5	1.5	1.9	-	2.1	5.0	6.9	350	1120	2150	5.1	4.9	4.7
	20+20+35	1.3	1.3	2.3	-	2.1	5.0	6.9	350	1120	2150	5.1	4.9	4.7
	20+25+25	1.4	1.8	1.8	-	2.1	5.0	6.9	350	1120	2150	5.1	4.9	4.7
	20+25+35	1.3	1.6	2.2	-	2.1	5.0	6.9	350	1120	2150	5.1	4.9	4.7
	25+25+25	1.7	1.7	1.7	-	2.1	5.0	6.9	350	1120	2150	5.1	4.9	4.7
25+25+35	1.5	1.5	2.1	-	2.1	5.0	6.9	350	1120	2150	5.1	4.9	4.7	

Heating		Heating capacity (kW)							Power consumption (W)			Standard current (A)		
Indoor unit combination		Indoor unit capacity (kW)				Total capacity (kW)			Min.	Standard	Max.	220V	230V	240V
		A	B	C	D	Min.	Standard	Max.						
1 unit	20	3	-	-	-	1.0	3.0	3.5	320	970	1100	4.5	4.3	4.1
	25	3.4	-	-	-	1.0	3.4	4.0	320	1140	1240	5.3	5.1	4.8
	35	4.5	-	-	-	1.0	4.5	4.8	320	1480	1490	6.9	6.6	6.3
	50	5.8	-	-	-	1.0	5.8	6.1	320	1780	2310	8.3	7.9	7.6
2 units	20+20	2.7	2.7	-	-	1.2	5.4	7.0	290	1350	2500	6.3	6.0	5.7
	20+25	2.6	3.3	-	-	1.2	5.9	7.0	290	1480	2500	6.9	6.6	6.3
	20+35	2.2	3.8	-	-	1.2	6.0	7.0	290	1500	2500	7.0	6.7	6.4
	20+50	1.7	4.3	-	-	1.2	6.0	7.0	290	1500	2500	7.0	6.7	6.4
	25+25	3.0	3.0	-	-	1.2	6.0	7.0	290	1500	2500	7.0	6.7	6.4
	25+35	2.5	3.5	-	-	1.2	6.0	7.0	290	1500	2500	7.0	6.7	6.4
	25+50	2.0	4.0	-	-	1.2	6.0	7.0	290	1500	2500	7.0	6.7	6.4
	35+35	3.0	3.0	-	-	1.2	6.0	7.0	290	1500	2500	7.0	6.7	6.4
3 units	35+50	2.5	3.5	-	-	1.2	6.0	7.0	290	1500	2500	7.0	6.7	6.4
	20+20+20	2.0	2.0	2.0	-	1.4	6.0	7.3	270	1300	2500	6.0	5.8	5.5
	20+20+25	1.8	1.8	2.3	-	1.4	6.0	7.3	270	1300	2500	6.0	5.8	5.5
	20+20+35	1.6	1.6	2.8	-	1.4	6.0	7.3	270	1300	2500	6.0	5.8	5.5
	20+25+25	1.7	2.1	2.1	-	1.4	6.0	7.3	270	1300	2500	6.0	5.8	5.5
	20+25+35	1.5	1.9	2.6	-	1.4	6.0	7.3	270	1300	2500	6.0	5.8	5.5
	25+25+25	2.0	2.0	2.0	-	1.4	6.0	7.3	270	1300	2500	6.0	5.8	5.5
25+25+35	1.8	1.8	2.5	-	1.4	6.0	7.3	270	1300	2500	6.0	5.8	5.5	

(2) Model SCM60ZS-W

(a) In case of indoor unit SRK-ZSX-W models only

Cooling		Cooling capacity (kW)							Power consumption(W)			Standard current(A)		
Indoor unit combination		Indoor unit capacity (kW)				Total capacity (kW)			Min.	Standard	Max.	220V	230V	240V
		A	B	C	D	Min.	Standard	Max.						
1 unit	20	2.0	-	-	-	1.7	2.0	2.8	430	500	950	2.4	2.3	2.2
	25	2.5	-	-	-	1.7	2.5	3.4	430	680	1080	3.2	3.1	3.0
	35	3.5	-	-	-	1.7	3.5	3.9	430	1010	1240	4.7	4.5	4.3
	50	5.0	-	-	-	1.7	5.0	6.1	430	1530	2100	7.0	6.7	6.4
	60	6.0	-	-	-	1.7	6.0	6.3	430	1880	2280	8.6	8.3	7.9
2 units	20+20	2.0	2.0	-	-	1.8	4.0	5.7	390	750	1750	3.5	3.3	3.2
	20+25	2.0	2.5	-	-	1.8	4.5	5.9	390	990	1910	4.6	4.4	4.2
	20+35	2.0	3.5	-	-	1.8	5.5	6.7	390	1320	2200	6.1	5.8	5.6
	20+50	1.7	4.3	-	-	1.8	6.0	6.9	390	1560	2280	7.2	6.9	6.6
	20+60	1.5	4.5	-	-	1.8	6.0	6.9	390	1560	2280	7.2	6.9	6.6
	25+25	2.5	2.5	-	-	1.8	5.0	6.5	390	1110	2150	5.1	4.9	4.7
	25+35	2.5	3.5	-	-	1.8	6.0	6.9	390	1560	2280	7.2	6.9	6.6
	25+50	2.0	4.0	-	-	1.8	6.0	6.9	390	1560	2280	7.2	6.9	6.6
	25+60	1.8	4.2	-	-	1.8	6.0	6.9	390	1560	2280	7.2	6.9	6.6
	35+35	3.0	3.0	-	-	1.8	6.0	6.9	390	1560	2280	7.2	6.9	6.6
	35+50	2.5	3.5	-	-	1.8	6.0	6.9	390	1560	2280	7.2	6.9	6.6
	35+60	2.2	3.8	-	-	1.8	6.0	6.9	390	1560	2280	7.2	6.9	6.6
	50+50	3.0	3.0	-	-	1.8	6.0	6.9	390	1560	2280	7.2	6.9	6.6
50+60	2.7	3.3	-	-	1.8	6.0	6.9	390	1560	2280	7.2	6.9	6.6	
3 units	20+20+20	2.0	2.0	2.0	-	2.1	6.0	7.5	350	1320	2280	6.1	5.8	5.6
	20+20+25	1.8	1.8	2.3	-	2.1	6.0	7.5	350	1320	2280	6.1	5.8	5.6
	20+20+35	1.6	1.6	2.8	-	2.1	6.0	7.5	350	1320	2280	6.1	5.8	5.6
	20+20+50	1.3	1.3	3.3	-	2.1	6.0	7.5	350	1320	2280	6.1	5.8	5.6
	20+20+60	1.2	1.2	3.6	-	2.1	6.0	7.5	350	1320	2280	6.1	5.8	5.6
	20+25+25	1.7	2.1	2.1	-	2.1	6.0	7.5	350	1320	2280	6.1	5.8	5.6
	20+25+35	1.5	1.9	2.6	-	2.1	6.0	7.5	350	1320	2280	6.1	5.8	5.6
	20+25+50	1.3	1.6	3.2	-	2.1	6.0	7.5	350	1320	2280	6.1	5.8	5.6
	20+25+60	1.1	1.4	3.4	-	2.1	6.0	7.5	350	1320	2280	6.1	5.8	5.6
	20+35+35	1.3	2.3	2.3	-	2.1	6.0	7.5	350	1320	2280	6.1	5.8	5.6
	20+35+50	1.1	2.0	2.9	-	2.1	6.0	7.5	350	1320	2280	6.1	5.8	5.6
	25+25+25	2.0	2.0	2.0	-	2.1	6.0	7.5	350	1320	2280	6.1	5.8	5.6
	25+25+35	1.8	1.8	2.5	-	2.1	6.0	7.5	350	1320	2280	6.1	5.8	5.6
	25+25+50	1.5	1.5	3.0	-	2.1	6.0	7.5	350	1320	2280	6.1	5.8	5.6
	25+25+60	1.4	1.4	3.3	-	2.1	6.0	7.5	350	1320	2280	6.1	5.8	5.6
	25+35+35	1.6	2.2	2.2	-	2.1	6.0	7.5	350	1320	2280	6.1	5.8	5.6
	25+35+50	1.4	1.9	2.7	-	2.1	6.0	7.5	350	1320	2280	6.1	5.8	5.6
35+35+35	2.0	2.0	2.0	-	2.1	6.0	7.5	350	1320	2280	6.1	5.8	5.6	

Heating		Heating capacity (kW)							Power consumption (W)			Standard current (A)		
Indoor unit combination		Indoor unit capacity (kW)				Total capacity (kW)			Min.	Standard	Max.	220V	230V	240V
		A	B	C	D	Min.	Standard	Max.						
1 unit	20	3.0	-	-	-	1.0	3.0	3.7	320	780	1100	3.6	3.5	3.3
	25	3.4	-	-	-	1.0	3.4	4.2	320	950	1240	4.4	4.2	4.0
	35	4.5	-	-	-	1.0	4.5	5.0	320	1270	1490	5.9	5.6	5.4
	50	5.8	-	-	-	1.0	5.8	6.5	320	1710	2310	7.9	7.6	7.3
	60	6.8	-	-	-	1.0	6.8	7.3	320	2040	2660	9.5	9.1	8.7
2 units	20+20	2.7	2.7	-	-	1.2	5.4	7.3	290	1050	2100	4.9	4.7	4.5
	20+25	2.6	3.3	-	-	1.2	5.9	7.5	290	1180	2550	5.5	5.2	5.0
	20+35	2.4	4.2	-	-	1.2	6.6	7.6	290	1360	2800	6.3	6.0	5.8
	20+50	1.9	4.9	-	-	1.2	6.8	7.6	290	1440	2800	6.7	6.4	6.1
	20+60	1.7	5.1	-	-	1.2	6.8	7.6	290	1440	2800	6.7	6.4	6.1
	25+25	3.2	3.2	-	-	1.2	6.4	7.6	290	1310	2800	6.1	5.8	5.6
	25+35	2.8	4.0	-	-	1.2	6.8	7.6	290	1440	2800	6.7	6.4	6.1
	25+50	2.3	4.5	-	-	1.2	6.8	7.6	290	1440	2800	6.7	6.4	6.1
	25+60	2.0	4.8	-	-	1.2	6.8	7.6	290	1440	2800	6.7	6.4	6.1
	35+35	3.4	3.4	-	-	1.2	6.8	7.6	290	1440	2800	6.7	6.4	6.1
	35+50	2.8	4.0	-	-	1.2	6.8	7.6	290	1440	2800	6.7	6.4	6.1
	35+60	2.5	4.3	-	-	1.2	6.8	7.6	290	1440	2800	6.7	6.4	6.1
	50+50	3.4	3.4	-	-	1.2	6.8	7.6	290	1440	2800	6.7	6.4	6.1
50+60	3.1	3.7	-	-	1.2	6.8	7.6	290	1440	2800	6.7	6.4	6.1	
3 units	20+20+20	2.3	2.3	2.3	-	1.4	6.8	7.8	270	1400	2800	6.5	6.2	6.0
	20+20+25	2.1	2.1	2.6	-	1.4	6.8	7.8	270	1400	2800	6.5	6.2	6.0
	20+20+35	1.8	1.8	3.2	-	1.4	6.8	7.8	270	1400	2800	6.5	6.2	6.0
	20+20+50	1.5	1.5	3.8	-	1.4	6.8	7.8	270	1400	2800	6.5	6.2	6.0
	20+20+60	1.4	1.4	4.1	-	1.4	6.8	7.8	270	1400	2800	6.5	6.2	6.0
	20+25+25	1.9	2.4	2.4	-	1.4	6.8	7.8	270	1400	2800	6.5	6.2	6.0
	20+25+35	1.7	2.1	3.0	-	1.4	6.8	7.8	270	1400	2800	6.5	6.2	6.0
	20+25+50	1.4	1.8	3.6	-	1.4	6.8	7.8	270	1400	2800	6.5	6.2	6.0
	20+25+60	1.3	1.6	3.9	-	1.4	6.8	7.8	270	1400	2800	6.5	6.2	6.0
	20+35+35	1.5	2.6	2.6	-	1.4	6.8	7.8	270	1400	2800	6.5	6.2	6.0
	20+35+50	1.3	2.3	3.2	-	1.4	6.8	7.8	270	1400	2800	6.5	6.2	6.0
	25+25+25	2.3	2.3	2.3	-	1.4	6.8	7.8	270	1400	2800	6.5	6.2	6.0
	25+25+35	2.0	2.0	2.8	-	1.4	6.8	7.8	270	1400	2800	6.5	6.2	6.0
	25+25+50	1.7	1.7	3.4	-	1.4	6.8	7.8	270	1400	2800	6.5	6.2	6.0
	25+25+60	1.5	1.5	3.7	-	1.4	6.8	7.8	270	1400	2800	6.5	6.2	6.0
	25+35+35	1.8	2.5	2.5	-	1.4	6.8	7.8	270	1400	2800	6.5	6.2	6.0
	25+35+50	1.5	2.2	3.1	-	1.4	6.8	7.8	270	1400	2800	6.5	6.2	6.0
35+35+35	2.3	2.3	2.3	-	1.4	6.8	7.8	270	1400	2800	6.5	6.2	6.0	

(b) In case of indoor unit other models

Cooling		Cooling capacity (kW)							Power consumption(W)			Standard current(A)		
Indoor unit combination		Indoor unit capacity (kW)				Total capacity (kW)			Min.	Standard	Max.	220V	230V	240V
		A	B	C	D	Min.	Standard	Max.						
1 unit	20	2.0	-	-	-	1.7	2.0	2.7	430	570	950	2.7	2.6	2.5
	25	2.5	-	-	-	1.7	2.5	3.2	430	760	1080	3.6	3.4	3.3
	35	3.5	-	-	-	1.7	3.5	3.7	430	1150	1240	5.3	5.1	4.9
	50	5.0	-	-	-	1.7	5.0	5.8	430	1860	2100	8.5	8.2	7.8
	60	6.0	-	-	-	1.7	6.0	6.1	430	2140	2280	9.8	9.4	9.0
2 units	20+20	2.0	2.0	-	-	1.8	4.0	5.6	390	800	1750	3.7	3.5	3.4
	20+25	2.0	2.5	-	-	1.8	4.5	5.8	390	1050	1910	4.8	4.6	4.4
	20+35	2.0	3.5	-	-	1.8	5.5	6.1	390	1620	2110	7.4	7.1	6.8
	20+50	1.7	4.3	-	-	1.8	6.0	6.7	390	1930	2280	8.9	8.5	8.1
	20+60	1.5	4.5	-	-	1.8	6.0	6.7	390	1930	2280	8.9	8.5	8.1
	25+25	2.5	2.5	-	-	1.8	5.0	6.1	390	1340	2110	6.2	5.9	5.6
	25+35	2.5	3.5	-	-	1.8	6.0	6.7	390	1930	2280	8.9	8.5	8.1
	25+50	2.0	4.0	-	-	1.8	6.0	6.7	390	1930	2280	8.9	8.5	8.1
	25+60	1.8	4.2	-	-	1.8	6.0	6.7	390	1930	2280	8.9	8.5	8.1
	35+35	3.0	3.0	-	-	1.8	6.0	6.7	390	1930	2280	8.9	8.5	8.1
	35+50	2.5	3.5	-	-	1.8	6.0	6.7	390	1930	2280	8.9	8.5	8.1
	35+60	2.2	3.8	-	-	1.8	6.0	6.7	390	1930	2280	8.9	8.5	8.1
3 units	50+50	3.0	3.0	-	-	1.8	6.0	6.7	390	1930	2280	8.9	8.5	8.1
	50+60	2.7	3.3	-	-	1.8	6.0	6.7	390	1930	2280	8.9	8.5	8.1
	20+20+20	2.0	2.0	2.0	-	2.1	6.0	7.3	350	1430	2280	6.6	6.3	6.0
	20+20+25	1.8	1.8	2.3	-	2.1	6.0	7.3	350	1430	2280	6.6	6.3	6.0
	20+20+35	1.6	1.6	2.8	-	2.1	6.0	7.3	350	1430	2280	6.6	6.3	6.0
	20+20+50	1.3	1.3	3.3	-	2.1	6.0	7.3	350	1430	2280	6.6	6.3	6.0
	20+20+60	1.2	1.2	3.6	-	2.1	6.0	7.3	350	1430	2280	6.6	6.3	6.0
	20+25+25	1.7	2.1	2.1	-	2.1	6.0	7.3	350	1430	2280	6.6	6.3	6.0
	20+25+35	1.5	1.9	2.6	-	2.1	6.0	7.3	350	1430	2280	6.6	6.3	6.0
	20+25+50	1.3	1.6	3.2	-	2.1	6.0	7.3	350	1430	2280	6.6	6.3	6.0
	20+25+60	1.1	1.4	3.4	-	2.1	6.0	7.3	350	1430	2280	6.6	6.3	6.0
	20+35+35	1.3	2.3	2.3	-	2.1	6.0	7.3	350	1430	2280	6.6	6.3	6.0
	20+35+50	1.1	2.0	2.9	-	2.1	6.0	7.3	350	1430	2280	6.6	6.3	6.0
	25+25+25	2.0	2.0	2.0	-	2.1	6.0	7.3	350	1430	2280	6.6	6.3	6.0
	25+25+35	1.8	1.8	2.5	-	2.1	6.0	7.3	350	1430	2280	6.6	6.3	6.0
	25+25+50	1.5	1.5	3.0	-	2.1	6.0	7.3	350	1430	2280	6.6	6.3	6.0
25+25+60	1.4	1.4	3.3	-	2.1	6.0	7.3	350	1430	2280	6.6	6.3	6.0	
25+35+35	1.6	2.2	2.2	-	2.1	6.0	7.3	350	1430	2280	6.6	6.3	6.0	
25+35+50	1.4	1.9	2.7	-	2.1	6.0	7.3	350	1430	2280	6.6	6.3	6.0	
35+35+35	2.0	2.0	2.0	-	2.1	6.0	7.3	350	1430	2280	6.6	6.3	6.0	

Heating		Heating capacity (kW)							Power consumption (W)			Standard current (A)		
Indoor unit combination		Indoor unit capacity (kW)				Total capacity (kW)			Min.	Standard	Max.	220V	230V	240V
		A	B	C	D	Min.	Standard	Max.						
1 unit	20	3.0	-	-	-	1.0	3.0	3.5	320	970	1330	4.5	4.3	4.1
	25	3.4	-	-	-	1.0	3.4	4.0	320	1140	1510	5.3	5.1	4.8
	35	4.5	-	-	-	1.0	4.5	4.8	320	1480	1790	6.9	6.6	6.3
	50	5.8	-	-	-	1.0	5.8	6.1	320	1910	2310	8.9	8.5	8.1
	60	6.8	-	-	-	1.0	6.8	7.0	320	2200	2660	10.2	9.8	9.4
2 units	20+20	2.7	2.7	-	-	1.2	5.4	7.0	290	1250	2100	5.8	5.5	5.3
	20+25	2.6	3.3	-	-	1.2	5.9	7.2	290	1380	2550	6.4	6.1	5.9
	20+35	2.4	4.2	-	-	1.2	6.6	7.3	290	1560	2800	7.2	6.9	6.6
	20+50	1.9	4.9	-	-	1.2	6.8	7.3	290	1640	2800	7.6	7.3	7.0
	20+60	1.7	5.1	-	-	1.2	6.8	7.3	290	1640	2800	7.6	7.3	7.0
	25+25	3.2	3.2	-	-	1.2	6.4	7.3	290	1510	2800	7.0	6.7	6.4
	25+35	2.8	4.0	-	-	1.2	6.8	7.3	290	1640	2800	7.6	7.3	7.0
	25+50	2.3	4.5	-	-	1.2	6.8	7.3	290	1640	2800	7.6	7.3	7.0
	25+60	2.0	4.8	-	-	1.2	6.8	7.3	290	1640	2800	7.6	7.3	7.0
	35+35	3.4	3.4	-	-	1.2	6.8	7.3	290	1640	2800	7.6	7.3	7.0
	35+50	2.8	4.0	-	-	1.2	6.8	7.3	290	1640	2800	7.6	7.3	7.0
	35+60	2.5	4.3	-	-	1.2	6.8	7.3	290	1640	2800	7.6	7.3	7.0
3 units	20+20+20	2.3	2.3	2.3	-	1.4	6.8	7.6	270	1500	2800	7.0	6.7	6.4
	20+20+25	2.1	2.1	2.6	-	1.4	6.8	7.6	270	1500	2800	7.0	6.7	6.4
	20+20+35	1.8	1.8	3.2	-	1.4	6.8	7.6	270	1500	2800	7.0	6.7	6.4
	20+20+50	1.5	1.5	3.8	-	1.4	6.8	7.6	270	1500	2800	7.0	6.7	6.4
	20+20+60	1.4	1.4	4.1	-	1.4	6.8	7.6	270	1500	2800	7.0	6.7	6.4
	20+25+25	1.9	2.4	2.4	-	1.4	6.8	7.6	270	1500	2800	7.0	6.7	6.4
	20+25+35	1.7	2.1	3.0	-	1.4	6.8	7.6	270	1500	2800	7.0	6.7	6.4
	20+25+50	1.4	1.8	3.6	-	1.4	6.8	7.6	270	1500	2800	7.0	6.7	6.4
	20+25+60	1.3	1.6	3.9	-	1.4	6.8	7.6	270	1500	2800	7.0	6.7	6.4
	20+35+35	1.5	2.6	2.6	-	1.4	6.8	7.6	270	1500	2800	7.0	6.7	6.4
	20+35+50	1.3	2.3	3.2	-	1.4	6.8	7.6	270	1500	2800	7.0	6.7	6.4
	25+25+25	2.3	2.3	2.3	-	1.4	6.8	7.6	270	1500	2800	7.0	6.7	6.4
	25+25+35	2.0	2.0	2.8	-	1.4	6.8	7.6	270	1500	2800	7.0	6.7	6.4
	25+25+50	1.7	1.7	3.4	-	1.4	6.8	7.6	270	1500	2800	7.0	6.7	6.4
	25+25+60	1.5	1.5	3.7	-	1.4	6.8	7.6	270	1500	2800	7.0	6.7	6.4
25+35+35	1.8	2.5	2.5	-	1.4	6.8	7.6	270	1500	2800	7.0	6.7	6.4	
25+35+50	1.5	2.2	3.1	-	1.4	6.8	7.6	270	1500	2800	7.0	6.7	6.4	
35+35+35	2.3	2.3	2.3	-	1.4	6.8	7.6	270	1500	2800	7.0	6.7	6.4	

6. SELECTION CHARTS

Correct the cooling and heating capacity in accordance with the conditions as follows. The net cooling and heating capacity can be obtained in the following way.

Net capacity = Capacity shown on specification × Correction factors as follows.

(1) Coefficient of cooling and heating capacity in relation to temperatures

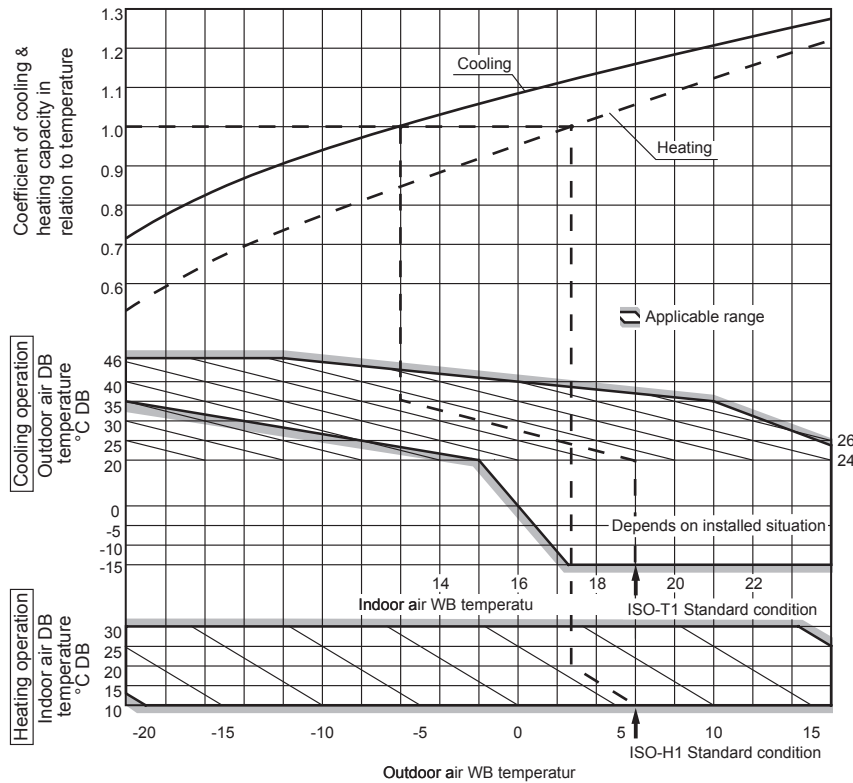

(2) Correction of cooling and heating capacity in relation to one way length of refrigerant piping

It is necessary to correct the cooling and heating capacity in relation to the one way piping length between the indoor and outdoor units.

Piping length [m]	7	10	15	20	25
Cooling	1.0	0.99	0.975	0.965	0.95
Heating	1.0	1.0	1.0	1.0	1.0

(3) Correction relative to frosting on outdoor heat exchanger during heating

In additions to the foregoing corrections (1), (2) the heating capacity needs to be adjusted also with respect to the frosting on the outdoor heat exchanger.

Air inlet temperature of outdoor unit in °CWB	-15	-10	-9	-7	-5	-3	-1	1	3	5 or more
Adjustment coefficient	0.95	0.95	0.94	0.93	0.91	0.88	0.86	0.87	0.92	1.00

How to obtain the cooling and heating capacity

Example : The net cooling capacity of the model SCM50ZS-W (SRK25ZSX-W : 3 units) with the piping length of 10m, indoor wet-bulb temperature at 19.0°C and outdoor dry-bulb temperature 35°C is

$$\text{Net cooling capacity} = \frac{(1.87 \times 3)}{\text{Table of indoor unit combination}} \times \frac{0.99}{\text{Length 10m}} \times \frac{1.0}{\text{Factor by air temperatures}} \doteq 5.55\text{kW}$$

Outdoor unit SCM50ZS-W
 Indoor unit SRK25ZSX-W × 3 units

7. TECHNICAL INFORMATION

(1) Model SCM50ZS-W

Information to identify the model(s) to which the information relates to:				If function includes heating: Indicate the heating season the information relates to. Indicated values should relate to one heating season at a time. Include at least the heating season 'Average'.			
Indoor unit model name		SRK20ZSX-W x 3units		Average(mandatory)		Yes	
Outdoor unit model name		SCM50ZS-W		Warmer(if designated)		Yes	
Function(indicate if present)				Colder(if designated)			
cooling		Yes					
heating		Yes					
Item				Item			
		symbol value unit				symbol value class	
Design load				Seasonal efficiency and energy efficiency class			
cooling		Pdesignc 5.00 kW		cooling		SEER 8.80 A+++	
heating / Average		Pdesignh 4.70 kW		heating / Average		SCOP/A 4.60 A++	
heating / Warmer		Pdesignh 6.40 kW		heating / Warmer		SCOP/W 6.20 A+++	
heating / Colder		Pdesignh - kW		heating / Colder		SCOP/C - -	
Declared capacity at outdoor temperature Tdesignh				Back up heating capacity at outdoor temperature Tdesignh			
heating / Average (-10°C)		Pdh 4.70 kW		heating / Average (-10°C)		elbu 0 kW	
heating / Warmer (2°C)		Pdh 6.40 kW		heating / Warmer (2°C)		elbu 0 kW	
heating / Colder (-22°C)		Pdh - kW		heating / Colder (-22°C)		elbu - kW	
Declared capacity for cooling, at indoor temperature 27(19)°C and outdoor temperature Tj				Declared energy efficiency ratio, at indoor temperature 27(19)°C and outdoor temperature Tj			
Tj=35°C		Pdc 5.00 kW		Tj=35°C		EERd 5.00 -	
Tj=30°C		Pdc 3.65 kW		Tj=30°C		EERd 7.60 -	
Tj=25°C		Pdc 2.69 kW		Tj=25°C		EERd 12.90 -	
Tj=20°C		Pdc 2.60 kW		Tj=20°C		EERd 14.20 -	
Declared capacity for heating / Average season, at indoor temperature 20°C and outdoor temperature Tj				Declared coefficient of performance / Average season, at indoor temperature 20°C and outdoor temperature Tj			
Tj=-7°C		Pdh 3.98 kW		Tj=-7°C		COPd 3.40 -	
Tj=2°C		Pdh 2.49 kW		Tj=2°C		COPd 4.37 -	
Tj=7°C		Pdh 1.57 kW		Tj=7°C		COPd 5.80 -	
Tj=12°C		Pdh 1.74 kW		Tj=12°C		COPd 7.60 -	
Tj=bivalent temperature		Pdh 4.70 kW		Tj=bivalent temperature		COPd 2.65 -	
Tj=operating limit		Pdh 4.13 kW		Tj=operating limit		COPd 2.35 -	
Declared capacity for heating / Warmer season, at indoor temperature 20°C and outdoor temperature Tj				Declared coefficient of performance / Warmer season, at indoor temperature 20°C and outdoor temperature Tj			
Tj=2°C		Pdh 6.40 kW		Tj=2°C		COPd 3.30 -	
Tj=7°C		Pdh 4.07 kW		Tj=7°C		COPd 5.72 -	
Tj=12°C		Pdh 1.74 kW		Tj=12°C		COPd 7.60 -	
Tj=bivalent temperature		Pdh 6.40 kW		Tj=bivalent temperature		COPd 3.30 -	
Tj=operating limit		Pdh 4.13 kW		Tj=operating limit		COPd 2.35 -	
Declared capacity for heating / Colder season, at indoor temperature 20°C and outdoor temperature Tj				Declared coefficient of performance / Colder season, at indoor temperature 20°C and outdoor temperature Tj			
Tj=-7°C		Pdh - kW		Tj=-7°C		COPd - -	
Tj=2°C		Pdh - kW		Tj=2°C		COPd - -	
Tj=7°C		Pdh - kW		Tj=7°C		COPd - -	
Tj=12°C		Pdh - kW		Tj=12°C		COPd - -	
Tj=bivalent temperature		Pdh - kW		Tj=bivalent temperature		COPd - -	
Tj=operating limit		Pdh - kW		Tj=operating limit		COPd - -	
Tj=-15°C		Pdh - kW		Tj=-15°C		COPd - -	
Bivalent temperature				Operating limit temperature			
heating / Average		Tbiv -10 °C		heating / Average		Tol -15 °C	
heating / Warmer		Tbiv 2 °C		heating / Warmer		Tol -15 °C	
heating / Colder		Tbiv - °C		heating / Colder		Tol - °C	
Cycling interval capacity				Cycling interval efficiency			
for cooling		Pcycc - kW		for cooling		EERcyc - -	
for heating		Pcyh - kW		for heating		COPcyc - -	
Degradation coefficient				Degradation coefficient			
cooling		Cdc 0.25 -		heating		Cdh 0.25 -	
Electric power input in power modes other than 'active mode'				Annual electricity consumption			
off mode		Poff 8 W		cooling		Qce 199 kWh/a	
standby mode		Psb 8 W		heating / Average		Qhe 1430 kWh/a	
thermostat-off mode		Pto(cooling) 25 W		heating / Warmer		Qhe 1445 kWh/a	
		Pto(heating) 35 W		heating / colder		Qhe - kWh/a	
crankcase heater mode		Pck 0 W					
Capacity control(indicate one of three options)				Other items			
fixed		No		Sound power level(indoor)		Lwa 53 dB(A)	
staged		No		Sound power level(outdoor)		Lwa 62 dB(A)	
variable		Yes		Global warming potential		GWP 675 kgCO2eq.	
				Rated air flow(indoor)		- 678 m3/h	
				Rated air flow(outdoor)		- 2460 m3/h	
Contact details for obtaining more information				Name and address of the manufacturer or of its authorised representative.			
				Mitsubishi Heavy Industries Air-Conditioning Europe, Ltd.			
				5 The Square, Stockley Park, Uxbridge, Middlesex, UB11 1ET, United kingdom			

RWC000Z338

Information to identify the model(s) to which the information relates to: Indoor unit model name SRK25ZSX-W + SRK25ZSX-W Outdoor unit model name SCM50ZS-W				If function includes heating: Indicate the heating season the information relates to. Indicated values should relate to one heating season at a time. Include at least the heating season 'Average'.			
Function(indicate if present)				Average(mandatory)			
cooling Yes				Warmer(if designated) Yes			
heating Yes				Colder(if designated) No			
Item symbol value unit				Item symbol value class			
Design load				Seasonal efficiency and energy efficiency class			
cooling Pdesignc 5.00 kW				cooling SEER 8.60 A+++			
heating / Average Pdesignh 4.80 kW				heating / Average SCOP/A 4.70 A++			
heating / Warmer Pdesignh 6.40 kW				heating / Warmer SCOP/W 6.40 A+++			
heating / Colder Pdesignh - kW				heating / Colder SCOP/C - -			
Declared capacity at outdoor temperature Tdesignh				Back up heating capacity at outdoor temperature Tdesignh			
heating / Average (-10°C) Pdh 4.80 kW				heating / Average (-10°C) elbu 0 kW			
heating / Warmer (2°C) Pdh 6.40 kW				heating / Warmer (2°C) elbu 0 kW			
heating / Colder (-22°C) Pdh - kW				heating / Colder (-22°C) elbu - kW			
Declared capacity for cooling, at indoor temperature 27(19)°C and outdoor temperature Tj				Declared energy efficiency ratio, at indoor temperature 27(19)°C and outdoor temperature Tj			
Tj=35°C Pdc 5.00 kW				Tj=35°C EERd 4.50 -			
Tj=30°C Pdc 3.60 kW				Tj=30°C EERd 6.90 -			
Tj=25°C Pdc 2.60 kW				Tj=25°C EERd 12.00 -			
Tj=20°C Pdc 2.65 kW				Tj=20°C EERd 14.30 -			
Declared capacity for heating / Average season, at indoor temperature 20°C and outdoor temperature Tj				Declared coefficient of performance / Average season, at indoor temperature 20°C and outdoor temperature Tj			
Tj=-7°C Pdh 4.10 kW				Tj=-7°C COPd 3.15 -			
Tj=2°C Pdh 2.65 kW				Tj=2°C COPd 4.58 -			
Tj=7°C Pdh 1.65 kW				Tj=7°C COPd 6.00 -			
Tj=12°C Pdh 1.95 kW				Tj=12°C COPd 8.00 -			
Tj=bivalent temperature Pdh 4.80 kW				Tj=bivalent temperature COPd 2.65 -			
Tj=operating limit Pdh 4.35 kW				Tj=operating limit COPd 2.40 -			
Declared capacity for heating / Warmer season, at indoor temperature 20°C and outdoor temperature Tj				Declared coefficient of performance / Warmer season, at indoor temperature 20°C and outdoor temperature Tj			
Tj=2°C Pdh 6.40 kW				Tj=2°C COPd 3.10 -			
Tj=7°C Pdh 4.05 kW				Tj=7°C COPd 5.85 -			
Tj=12°C Pdh 1.95 kW				Tj=12°C COPd 8.00 -			
Tj=bivalent temperature Pdh 6.40 kW				Tj=bivalent temperature COPd 3.10 -			
Tj=operating limit Pdh 4.35 kW				Tj=operating limit COPd 2.40 -			
Declared capacity for heating / Colder season, at indoor temperature 20°C and outdoor temperature Tj				Declared coefficient of performance / Colder season, at indoor temperature 20°C and outdoor temperature Tj			
Tj=-7°C Pdh - kW				Tj=-7°C COPd - -			
Tj=2°C Pdh - kW				Tj=2°C COPd - -			
Tj=7°C Pdh - kW				Tj=7°C COPd - -			
Tj=12°C Pdh - kW				Tj=12°C COPd - -			
Tj=bivalent temperature Pdh - kW				Tj=bivalent temperature COPd - -			
Tj=operating limit Pdh - kW				Tj=operating limit COPd - -			
Tj=-15°C Pdh - kW				Tj=-15°C COPd - -			
Bivalent temperature				Operating limit temperature			
heating / Average Tbiv -10 °C				heating / Average Tol -15 °C			
heating / Warmer Tbiv 2 °C				heating / Warmer Tol -15 °C			
heating / Colder Tbiv - °C				heating / Colder Tol - °C			
Cycling interval capacity				Cycling interval efficiency			
for cooling Pcycc - kW				for cooling EERcyc - -			
for heating Pcych - kW				for heating COPcyc - -			
Degradation coefficient				Degradation coefficient			
cooling Cdc 0.25 -				heating Cdh 0.25 -			
Electric power input in power modes other than 'active mode'				Annual electricity consumption			
off mode Poff 6 W				cooling Qce 204 kWh/a			
standby mode Psb 6 W				heating / Average Qhe 1430 kWh/a			
thermostat-off mode Pto(cooling) 20 W				heating / Warmer Qhe 1400 kWh/a			
Pto(heating) 30 W				heating / colder Qhe - kWh/a			
crankcase heater mode Pck 0 W							
Capacity control(indicate one of three options)				Other items			
fixed No				Sound power level(indoor) Lwa 55 dB(A)			
staged No				Sound power level(outdoor) Lwa 62 dB(A)			
variable Yes				Global warming potential GWP 675 kgCO2eq.			
				Rated air flow(indoor) - 732 m3/h			
				Rated air flow(outdoor) - 2460 m3/h			
Contact details for obtaining more information		Name and address of the manufacturer or of its authorised representative. Mitsubishi Heavy Industries Air-Conditioning Europe, Ltd. 5 The Square, Stockley Park, Uxbridge, Middlesex, UB11 1ET, United kingdom					

(2) Model SCM60ZS-W

Information to identify the model(s) to which the information relates to:		If function includes heating: Indicate the heating season the information relates to. Indicated values should relate to one heating season at a time. Include at least the heating season 'Average'.	
Indoor unit model name	SRK20ZSX-W x 3units		
Outdoor unit model name	SCM60ZS-W		
Function(indicate if present)		Average(mandatory)	
cooling	Yes	Warmer(if designated)	Yes
heating	Yes	Colder(if designated)	No
Item	symbol	value	unit
Design load			
cooling	Pdesignc	6.00	kW
heating / Average	Pdesignh	4.70	kW
heating / Warmer	Pdesignh	6.40	kW
heating / Colder	Pdesignh	-	kW
Seasonal efficiency and energy efficiency class			
cooling	SEER	8.80	A+++
heating / Average	SCOP/A	4.60	A++
heating / Warmer	SCOP/W	6.20	A+++
heating / Colder	SCOP/C	-	-
Declared capacity at outdoor temperature Tdesignh			
heating / Average (-10°C)	Pdh	4.70	kW
heating / Warmer (2°C)	Pdh	6.40	kW
heating / Colder (-22°C)	Pdh	-	kW
Back up heating capacity at outdoor temperature Tdesignh			
heating / Average (-10°C)	elbu	0	kW
heating / Warmer (2°C)	elbu	0	kW
heating / Colder (-22°C)	elbu	-	kW
Declared capacity for cooling, at indoor temperature 27(19)°C and outdoor temperature Tj			
Tj=35°C	Pdc	6.00	kW
Tj=30°C	Pdc	4.20	kW
Tj=25°C	Pdc	2.69	kW
Tj=20°C	Pdc	2.60	kW
Declared energy efficiency ratio, at indoor temperature 27(19)°C and outdoor temperature Tj			
Tj=35°C	EERd	4.60	-
Tj=30°C	EERd	7.00	-
Tj=25°C	EERd	12.75	-
Tj=20°C	EERd	14.20	-
Declared capacity for heating / Average season, at indoor temperature 20°C and outdoor temperature Tj			
Tj=-7°C	Pdh	3.98	kW
Tj=2°C	Pdh	2.49	kW
Tj=7°C	Pdh	1.57	kW
Tj=12°C	Pdh	1.74	kW
Tj=bivalent temperature	Pdh	4.70	kW
Tj=operating limit	Pdh	4.13	kW
Declared coefficient of performance / Average season, at indoor temperature 20°C and outdoor temperature Tj			
Tj=-7°C	COPd	3.40	-
Tj=2°C	COPd	4.37	-
Tj=7°C	COPd	5.80	-
Tj=12°C	COPd	7.60	-
Tj=bivalent temperature	COPd	2.65	-
Tj=operating limit	COPd	2.35	-
Declared capacity for heating / Warmer season, at indoor temperature 20°C and outdoor temperature Tj			
Tj=2°C	Pdh	6.40	kW
Tj=7°C	Pdh	4.07	kW
Tj=12°C	Pdh	1.74	kW
Tj=bivalent temperature	Pdh	6.40	kW
Tj=operating limit	Pdh	4.13	kW
Declared coefficient of performance / Warmer season, at indoor temperature 20°C and outdoor temperature Tj			
Tj=2°C	COPd	3.30	-
Tj=7°C	COPd	5.72	-
Tj=12°C	COPd	7.60	-
Tj=bivalent temperature	COPd	3.30	-
Tj=operating limit	COPd	2.35	-
Declared capacity for heating / Colder season, at indoor temperature 20°C and outdoor temperature Tj			
Tj=-7°C	Pdh	-	kW
Tj=2°C	Pdh	-	kW
Tj=7°C	Pdh	-	kW
Tj=12°C	Pdh	-	kW
Tj=bivalent temperature	Pdh	-	kW
Tj=operating limit	Pdh	-	kW
Tj=-15°C	Pdh	-	kW
Declared coefficient of performance / Colder season, at indoor temperature 20°C and outdoor temperature Tj			
Tj=-7°C	COPd	-	-
Tj=2°C	COPd	-	-
Tj=7°C	COPd	-	-
Tj=12°C	COPd	-	-
Tj=bivalent temperature	COPd	-	-
Tj=operating limit	COPd	-	-
Tj=-15°C	COPd	-	-
Bivalent temperature			
heating / Average	Tbiv	-10	°C
heating / Warmer	Tbiv	2	°C
heating / Colder	Tbiv	-	°C
Operating limit temperature			
heating / Average	Tol	-15	°C
heating / Warmer	Tol	-15	°C
heating / Colder	Tol	-	°C
Cycling interval capacity			
for cooling	Pcycc	-	kW
for heating	Pcyh	-	kW
Cycling interval efficiency			
for cooling	EERcyc	-	-
for heating	COPcyc	-	-
Degradation coefficient			
cooling	Cdc	0.25	-
Degradation coefficient			
heating	Cdh	0.25	-
Electric power input in power modes other than 'active mode'			
off mode	Poff	8	W
standby mode	Psb	8	W
thermostat-off mode	Pto(cooling)	25	W
	Pto(heating)	35	W
crankcase heater mode	Pck	0	W
Annual electricity consumption			
cooling	Qce	239	kWh/a
heating / Average	Qhe	1430	kWh/a
heating / Warmer	Qhe	1445	kWh/a
heating / colder	Qhe	-	kWh/a
Capacity control(indicate one of three options)			
fixed		No	
staged		No	
variable		Yes	
Other items			
Sound power level(indoor)	Lwa	53	dB(A)
Sound power level(outdoor)	Lwa	62	dB(A)
Global warming potential	GWP	675	kgCO2eq.
Rated air flow(indoor)	-	678	m3/h
Rated air flow(outdoor)	-	2460	m3/h
Contact details for obtaining more information	Name and address of the manufacturer or of its authorised representative. Mitsubishi Heavy Industries Air-Conditioning Europe, Ltd. 5 The Square, Stockley Park, Uxbridge, Middlesex, UB11 1ET, United kingdom		

RWC000Z338

Information to identify the model(s) to which the information relates to: Indoor unit model name SRK35ZSX-W + SRK25ZSX-W Outdoor unit model name SCM60ZS-W		If function includes heating: Indicate the heating season the information relates to. Indicated values should relate to one heating season at a time. Include at least the heating season 'Average'.	
Function(indicate if present)		Average(mandatory)	
cooling	Yes	Warmer(if designated)	Yes
heating	Yes	Colder(if designated)	No
Item	symbol	value	unit
Design load			
cooling	Pdesignc	6.00	kW
heating / Average	Pdesignh	4.80	kW
heating / Warmer	Pdesignh	6.40	kW
heating / Colder	Pdesignh	-	kW
Declared capacity at outdoor temperature T _{designh}		Back up heating capacity at outdoor temperature T _{designh}	
heating / Average (-10°C)	Pdh	4.80	kW
heating / Warmer (2°C)	Pdh	6.40	kW
heating / Colder (-22°C)	Pdh	-	kW
Declared capacity for cooling, at indoor temperature 27(19)°C and outdoor temperature T _j		Declared energy efficiency ratio, at indoor temperature 27(19)°C and outdoor temperature T _j	
T _j =35°C	Pdc	6.00	kW
T _j =30°C	Pdc	4.40	kW
T _j =25°C	Pdc	2.80	kW
T _j =20°C	Pdc	2.65	kW
Declared capacity for heating / Average season, at indoor temperature 20°C and outdoor temperature T _j		Declared coefficient of performance / Average season, at indoor temperature 20°C and outdoor temperature T _j	
T _j =7°C	Pdh	4.10	kW
T _j =2°C	Pdh	2.60	kW
T _j =7°C	Pdh	1.65	kW
T _j =12°C	Pdh	1.95	kW
T _j =bivalent temperature	Pdh	4.80	kW
T _j =operating limit	Pdh	4.35	kW
Declared capacity for heating / Warmer season, at indoor temperature 20°C and outdoor temperature T _j		Declared coefficient of performance / Warmer season, at indoor temperature 20°C and outdoor temperature T _j	
T _j =2°C	Pdh	6.40	kW
T _j =7°C	Pdh	4.05	kW
T _j =12°C	Pdh	1.95	kW
T _j =bivalent temperature	Pdh	6.40	kW
T _j =operating limit	Pdh	4.35	kW
Declared capacity for heating / Colder season, at indoor temperature 20°C and outdoor temperature T _j		Declared coefficient of performance / Colder season, at indoor temperature 20°C and outdoor temperature T _j	
T _j =7°C	Pdh	-	kW
T _j =2°C	Pdh	-	kW
T _j =7°C	Pdh	-	kW
T _j =12°C	Pdh	-	kW
T _j =bivalent temperature	Pdh	-	kW
T _j =operating limit	Pdh	-	kW
T _j =-15°C	Pdh	-	kW
Bivalent temperature		Operating limit temperature	
heating / Average	Tbiv	-10	°C
heating / Warmer	Tbiv	2	°C
heating / Colder	Tbiv	-	°C
Cycling interval capacity		Cycling interval efficiency	
for cooling	Pcycc	-	kW
for heating	Pcyh	-	kW
Degradation coefficient		Degradation coefficient	
cooling	Cdc	0.25	-
Electric power input in power modes other than 'active mode'		Annual electricity consumption	
off mode	Poff	6	W
standby mode	Psb	6	W
thermostat-off mode	Pto(cooling)	20	W
crankcase heater mode	Pto(heating)	30	W
	Pck	0	W
Capacity control(indicate one of three options)		Other items	
fixed	No	Sound power level(indoor)	Lwa 58 dB(A)
staged	No	Sound power level(outdoor)	Lwa 63 dB(A)
variable	Yes	Global warming potential	GWP 675 kgCO ₂ eq.
Contact details for obtaining more information		Name and address of the manufacturer or of its authorised representative. Mitsubishi Heavy Industries Air-Conditioning Europe, Ltd. 5 The Square, Stockley Park, Uxbridge, Middlesex, UB11 1ET, United kingdom	

INVERTER MULTI-SPLIT SYSTEM RESIDENTIAL AIR-CONDITIONERS



MITSUBISHI HEAVY INDUSTRIES THERMAL SYSTEMS, LTD.

2-3, Marunouchi 3-chome, Chiyoda-ku, Tokyo, 100-8332, Japan
<http://www.mhi-mth.co.jp/en/>

Because of our policy of continuous improvement, we reserve the right to make changes in all specifications without notice.

© Copyright MITSUBISHI HEAVY INDUSTRIES THERMAL SYSTEMS, LTD.